

sketches by Jeanine Verloop  
made during the Summer Sessions  
at Hangar, Barcelona 2019

# MULLIAGEN

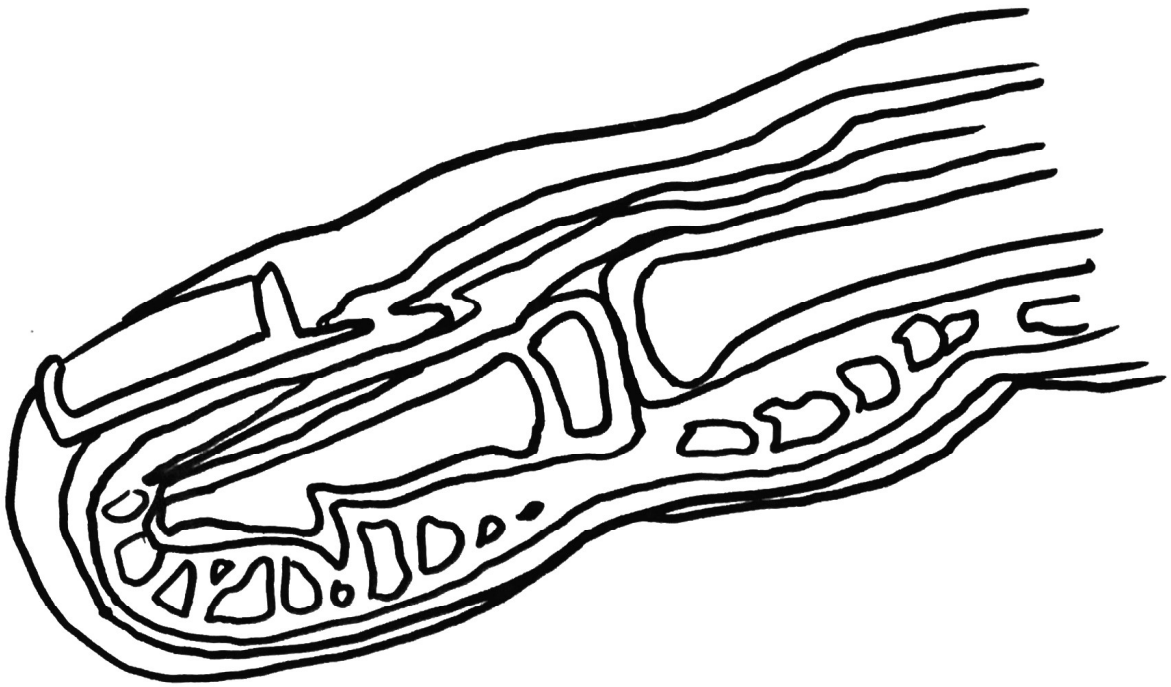

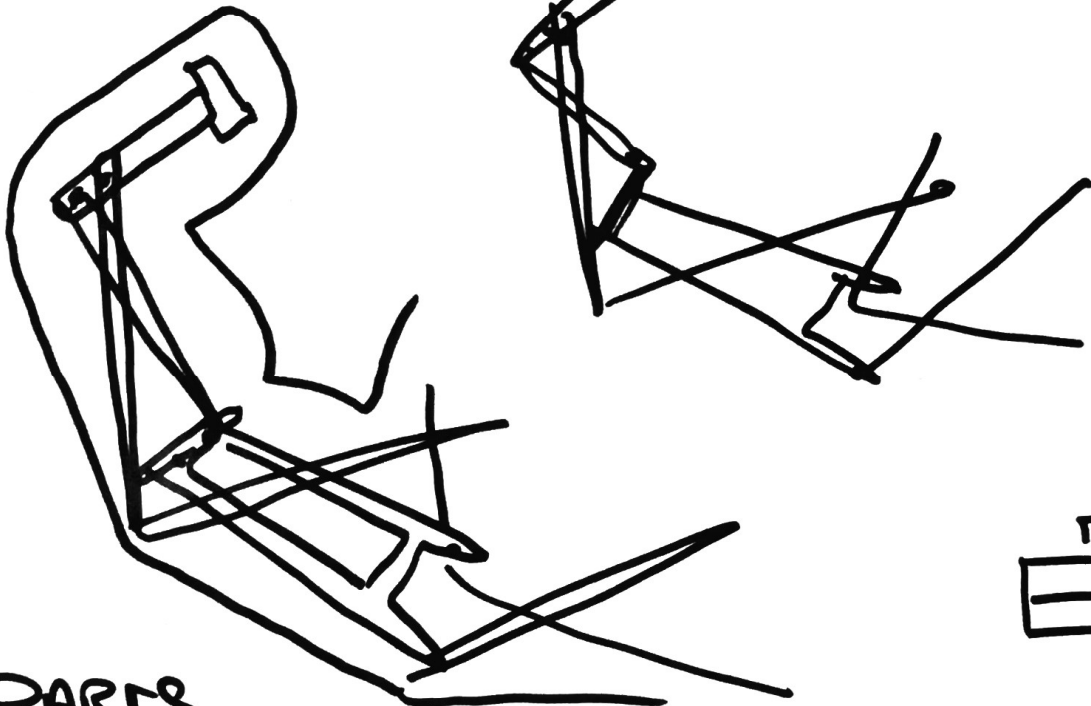
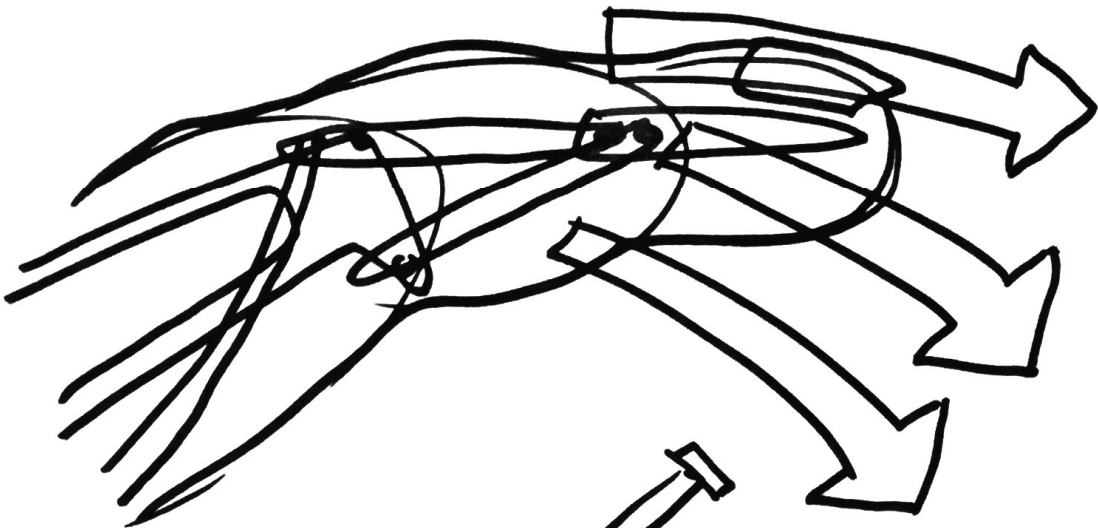

PARTS

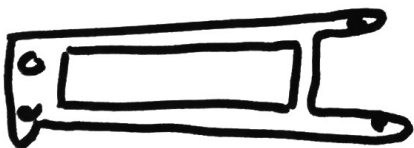
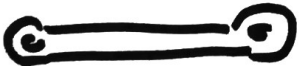
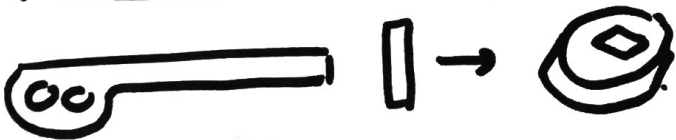

→ +? GEAR

TREK  
WAARM  
SCHEEF

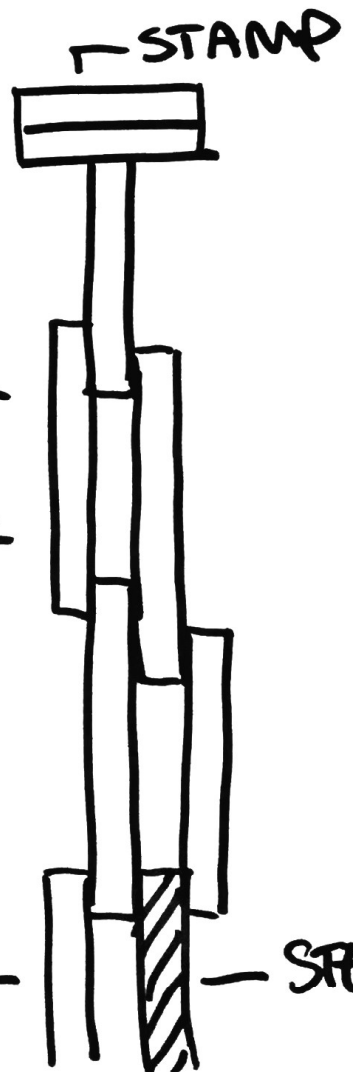

GEAR  
SIDE

STEUW

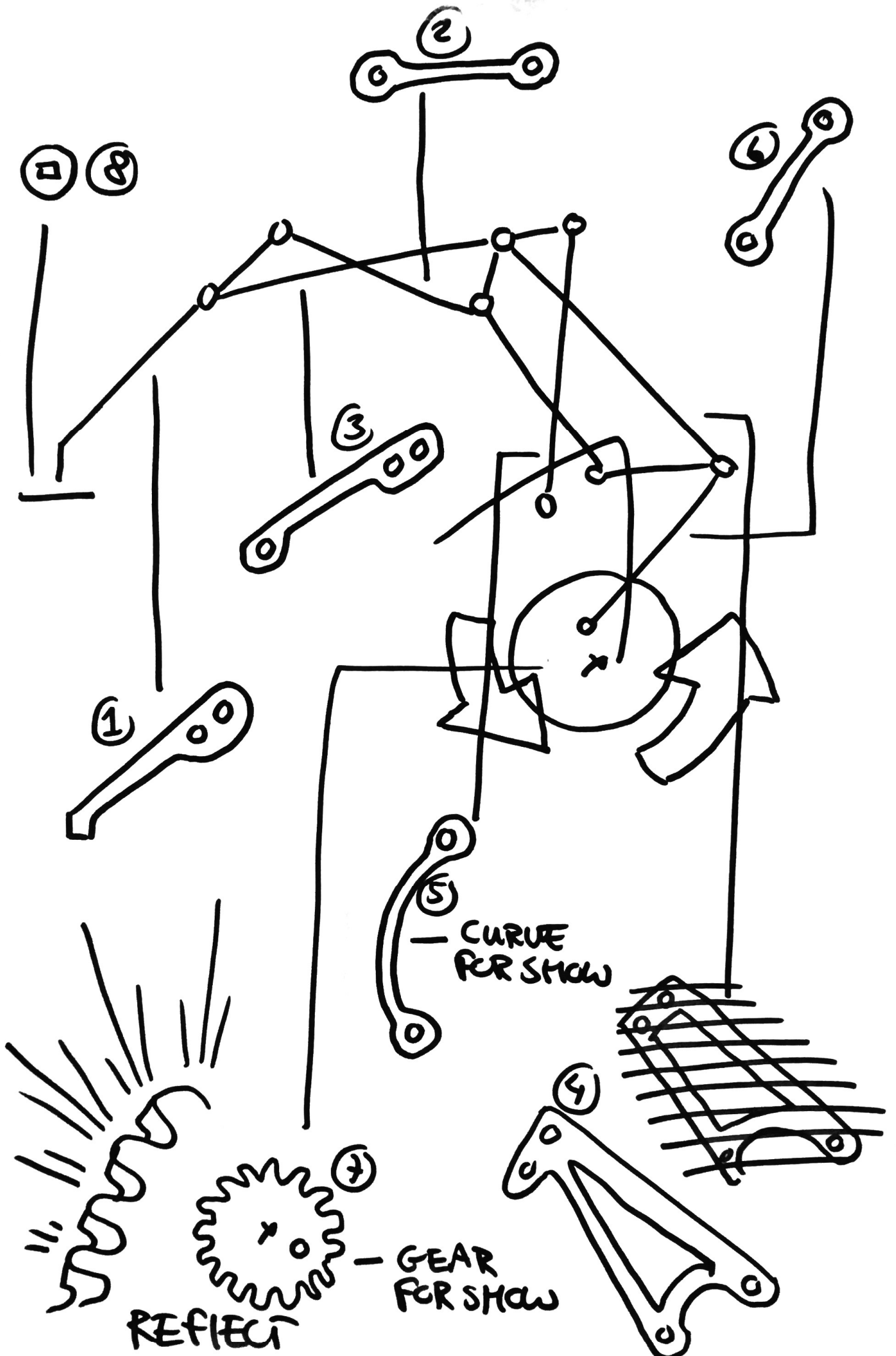



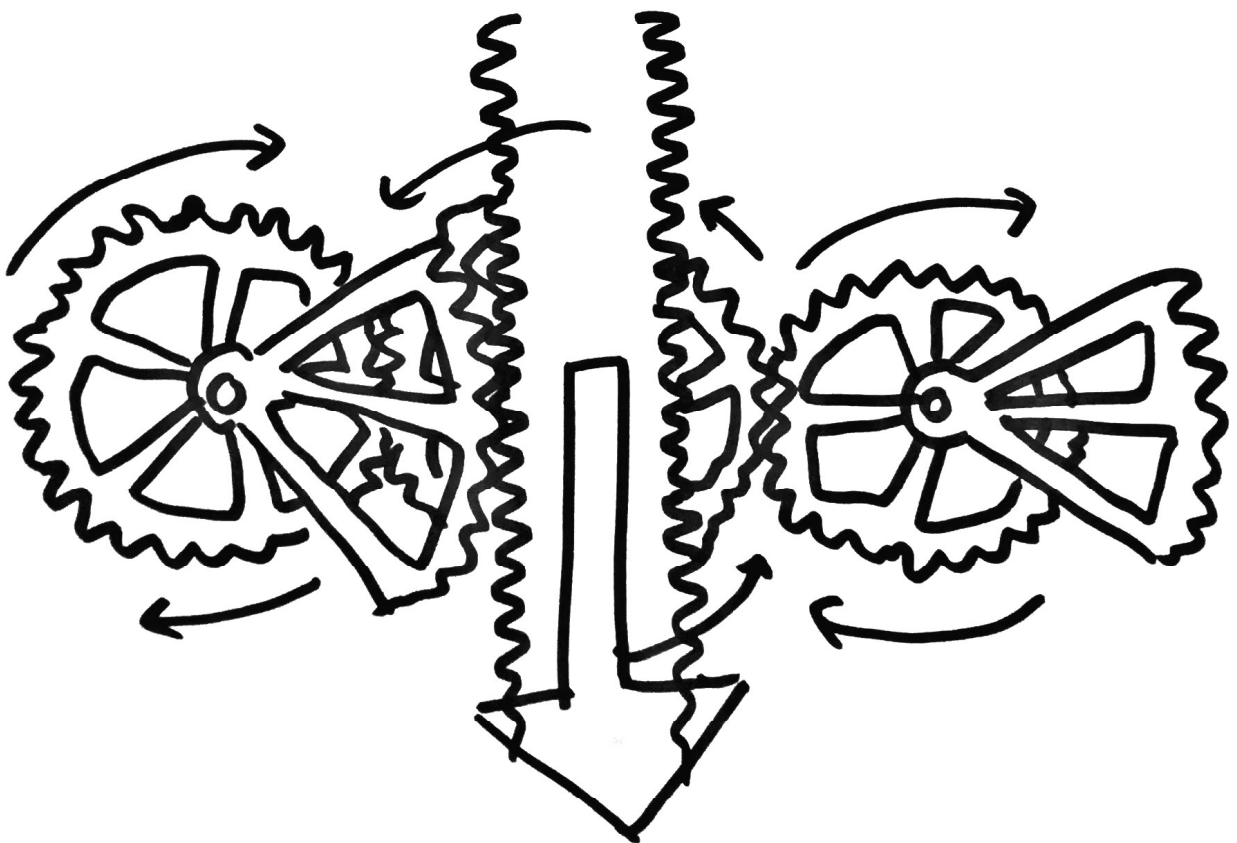
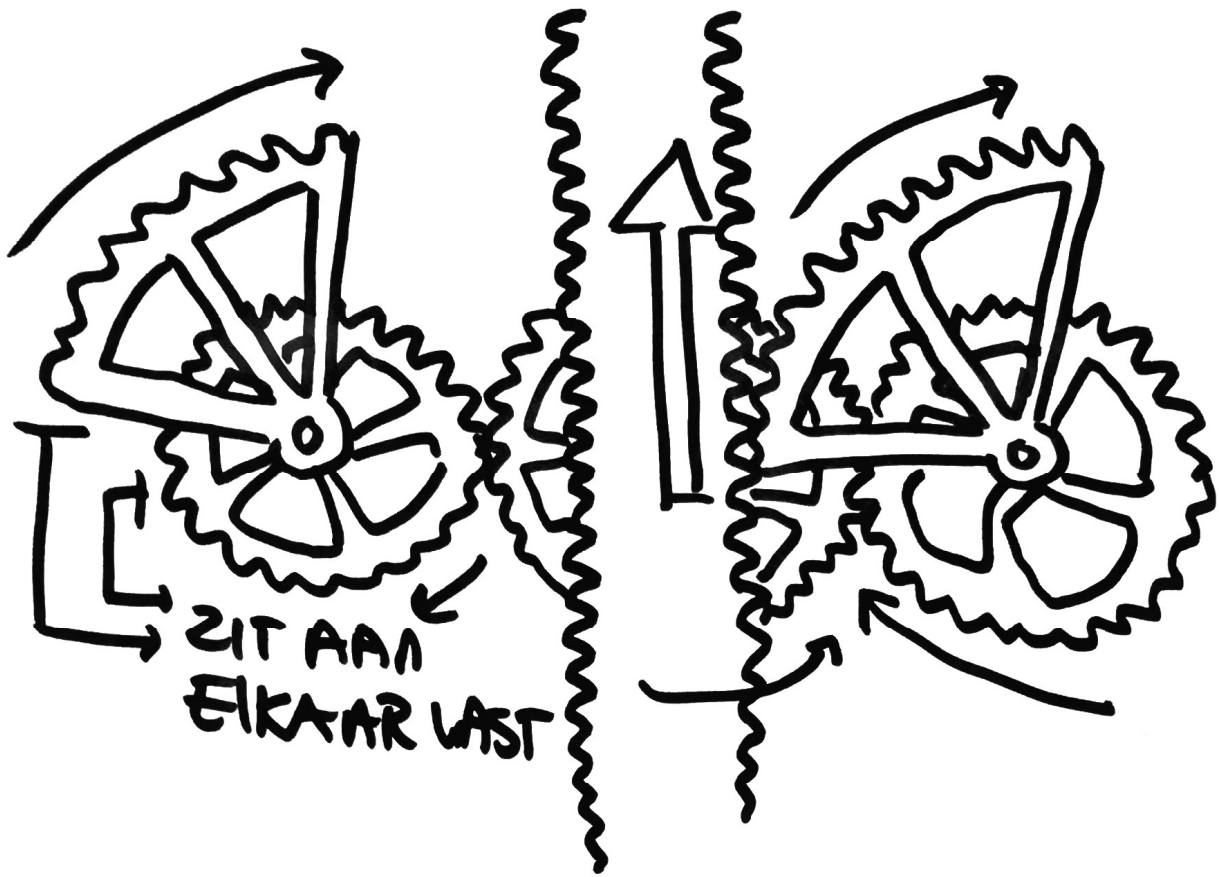

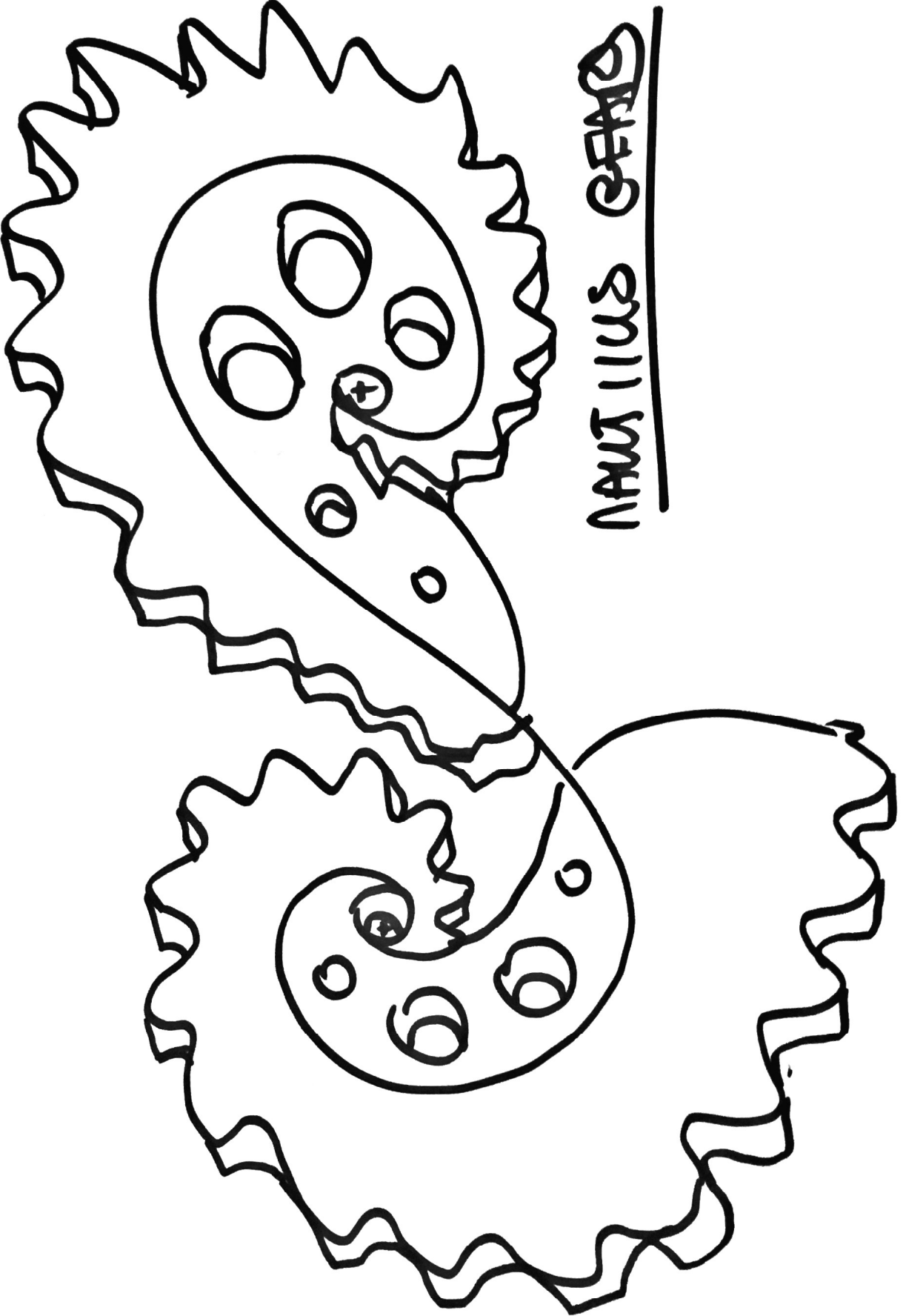

NAUTIIUS GEARS

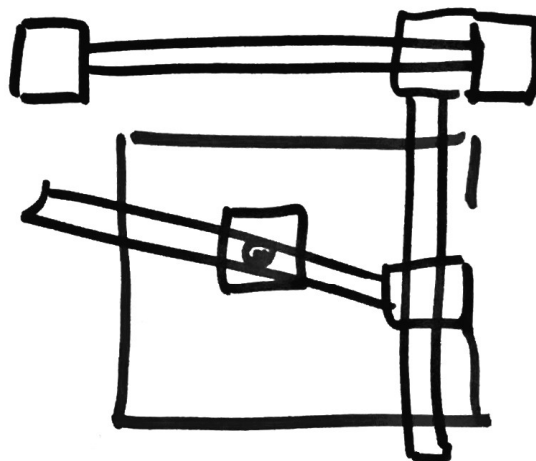
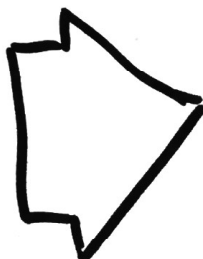
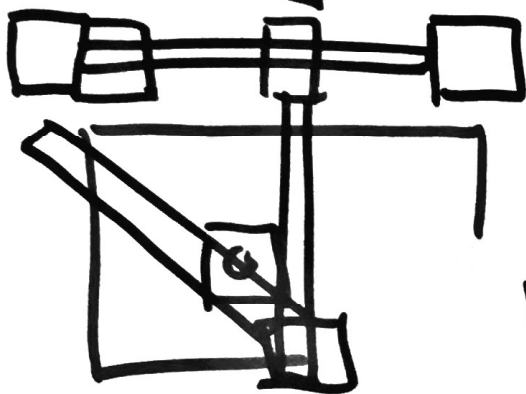
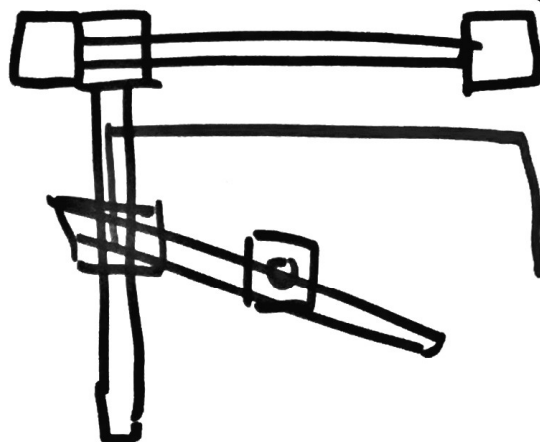
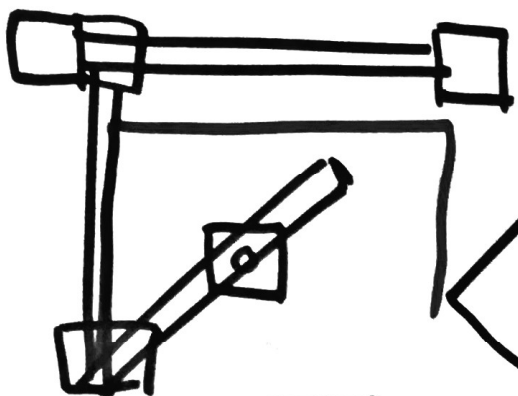
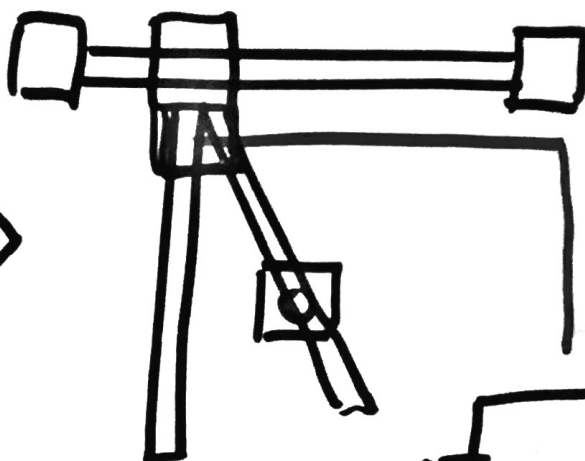
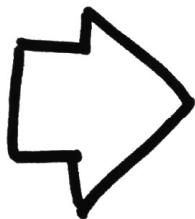
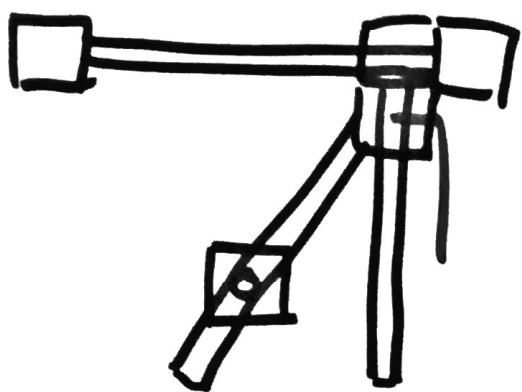

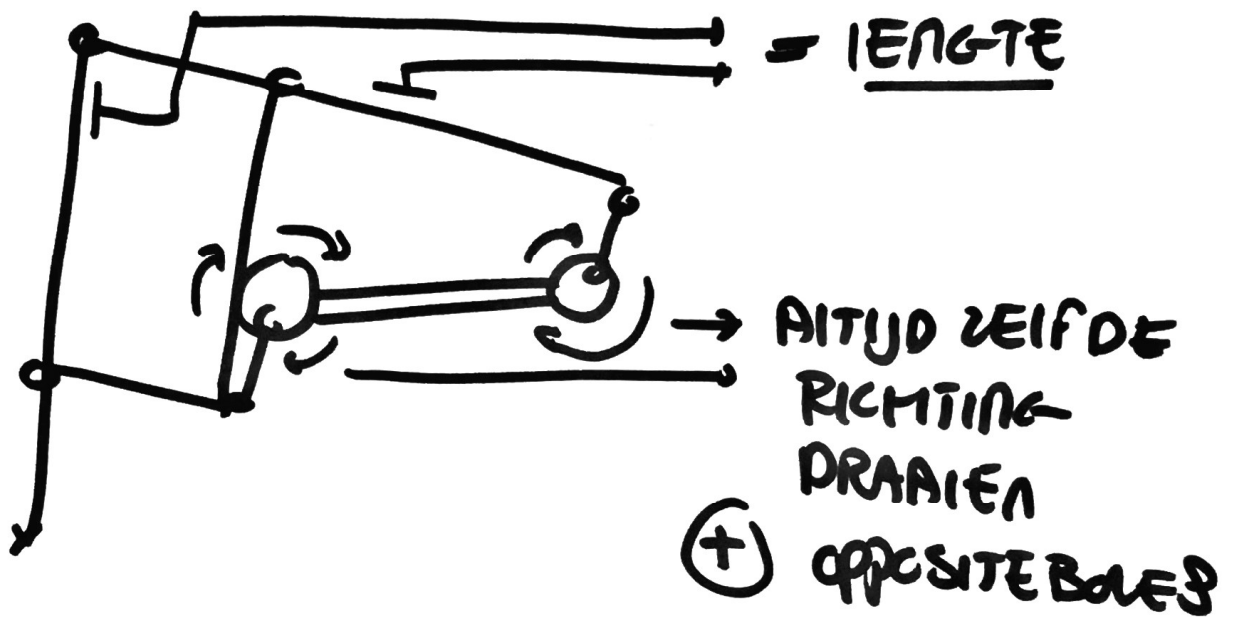
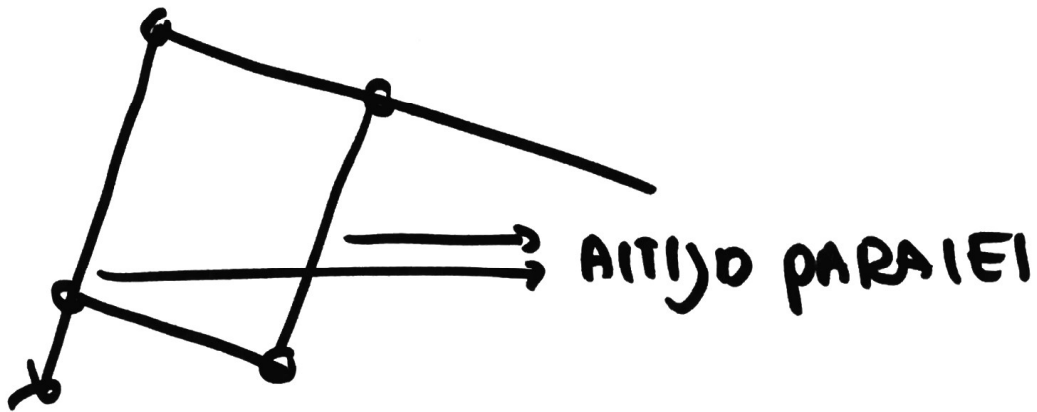

MECHANISM FOR  
DRAWING CIRCLE

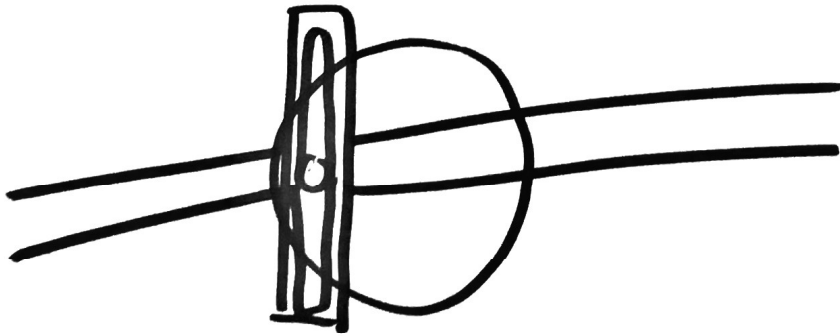
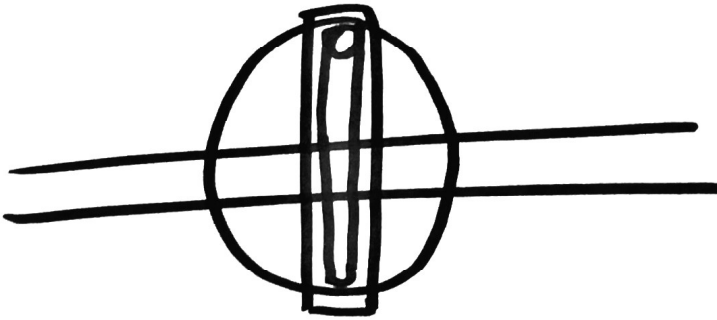
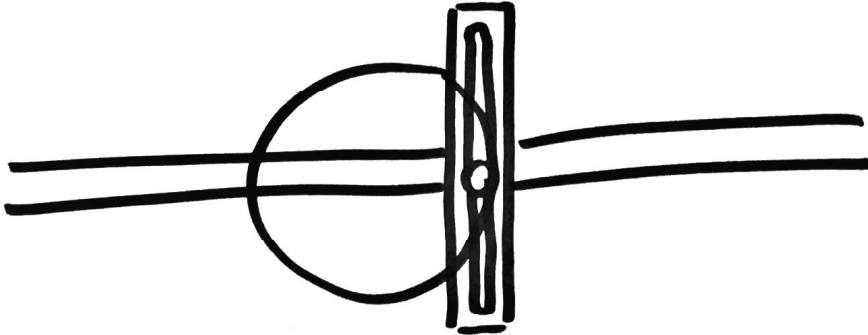
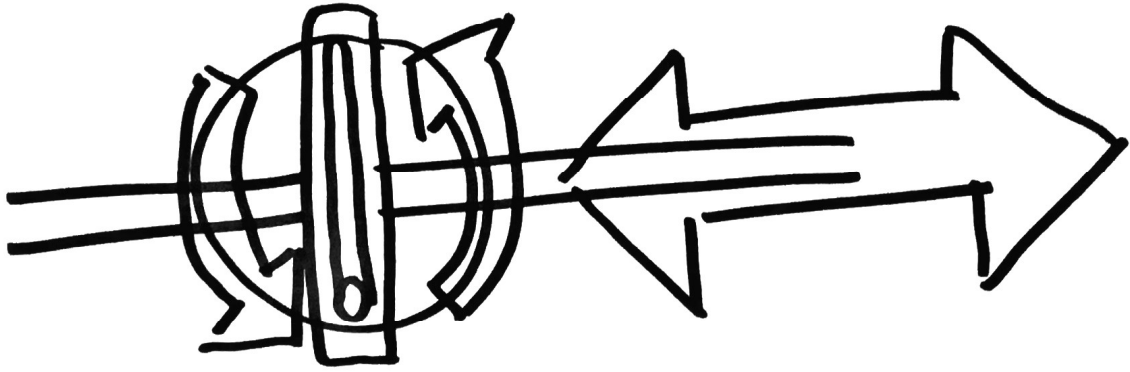

~~SCOTCH~~  
SCOTCH  
YOKE  
MACHINE

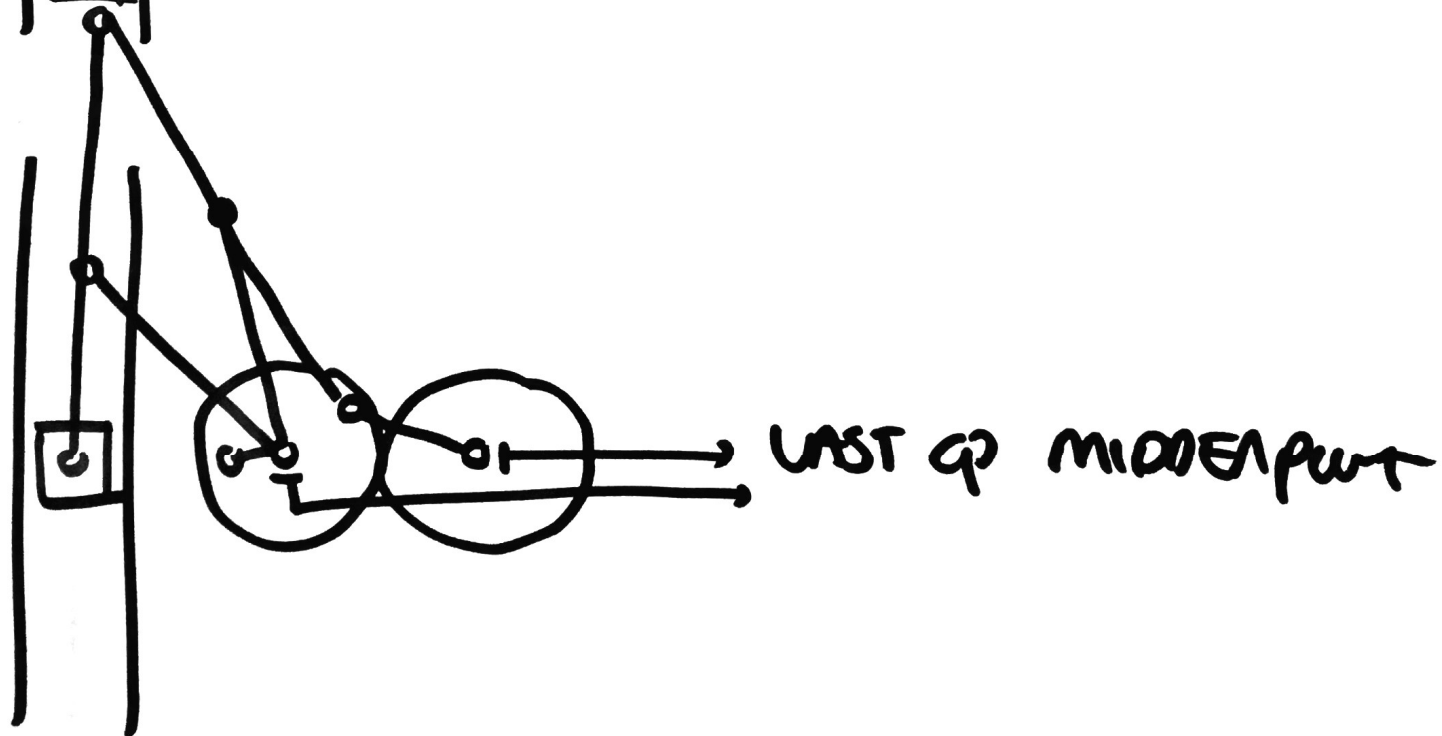
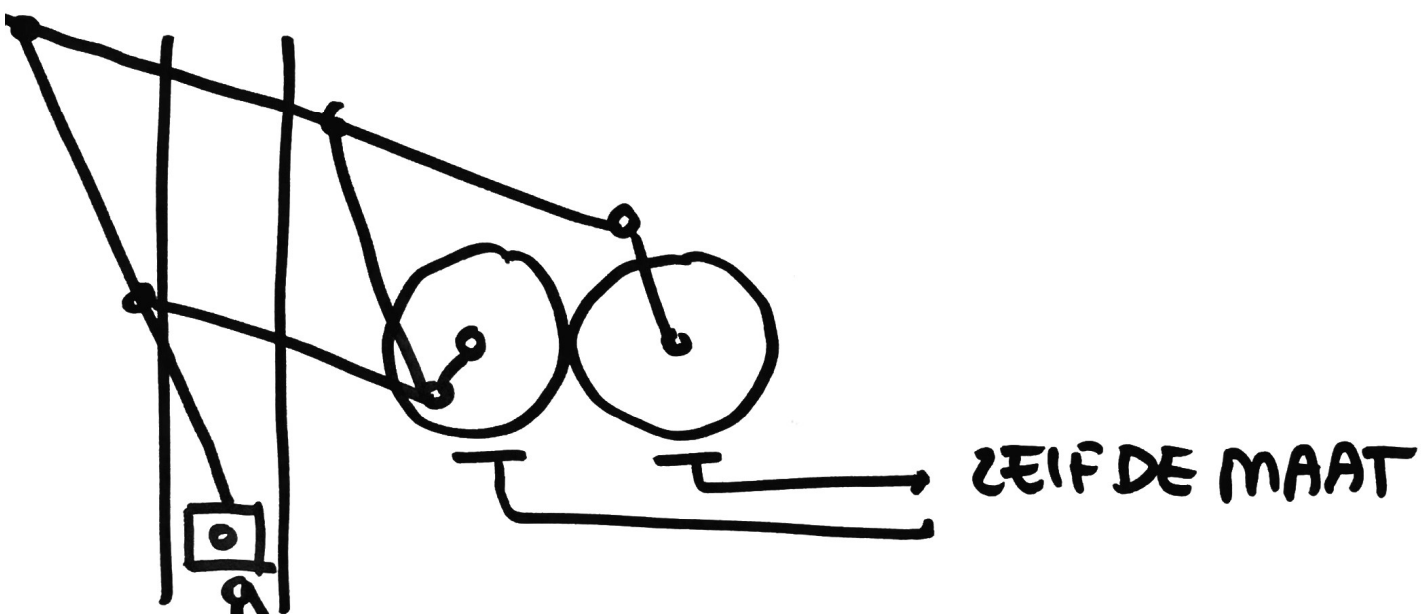
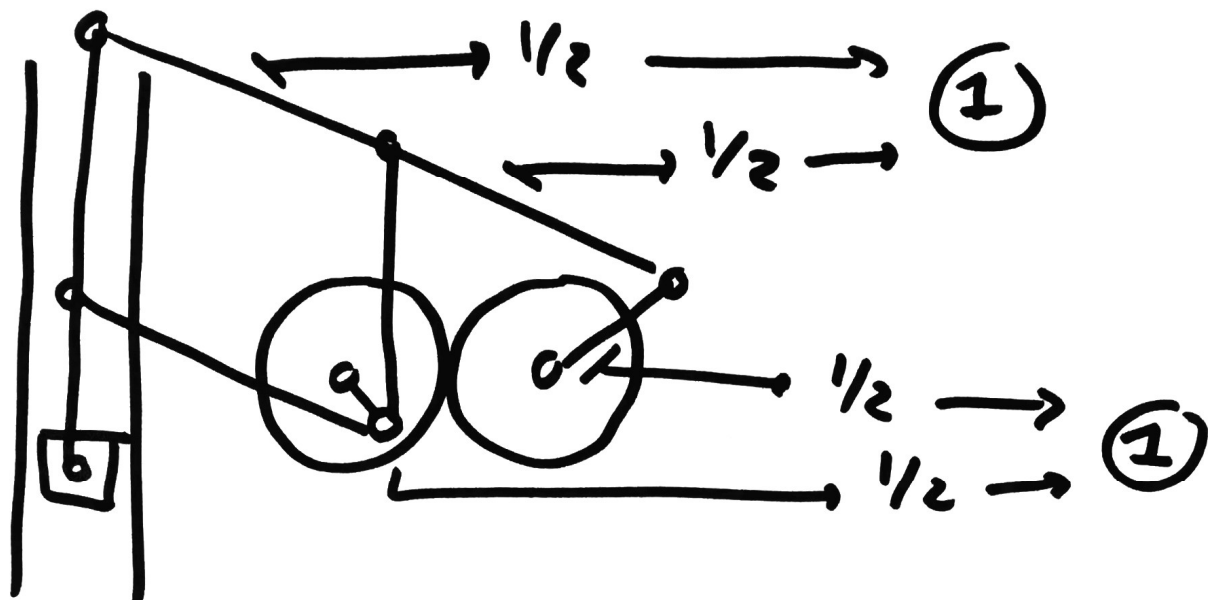

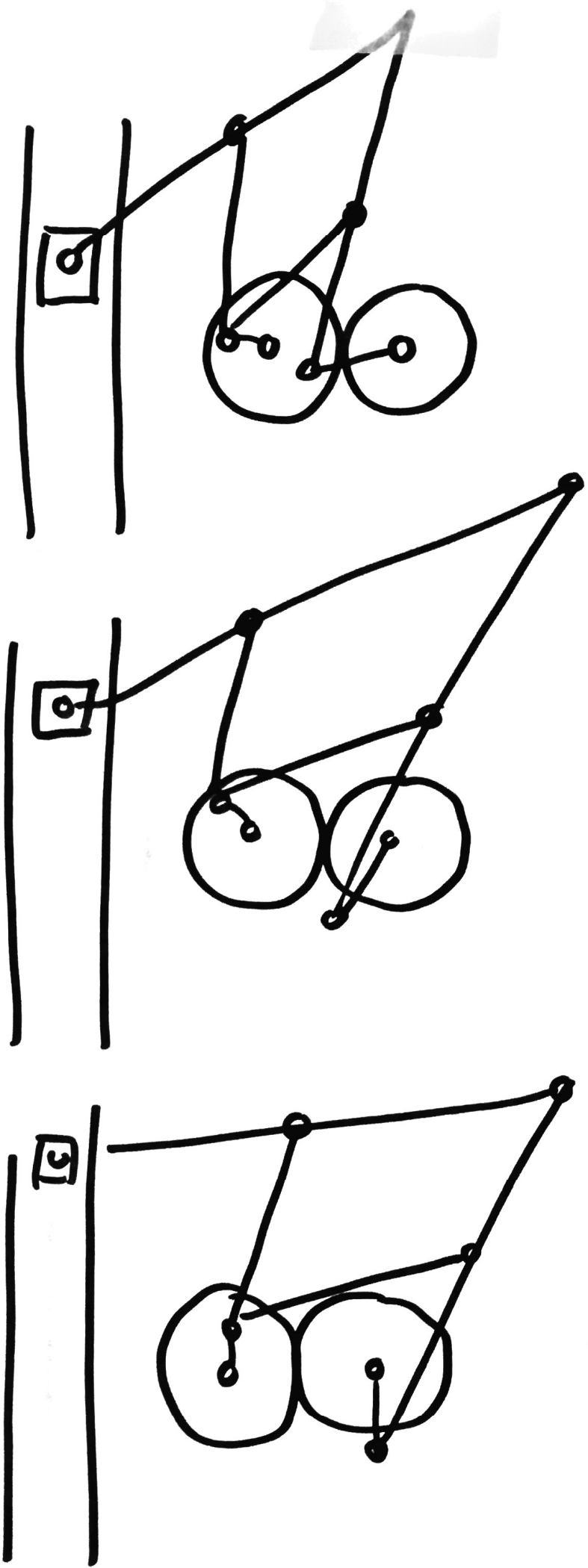

NOPIG:  
 CONSTANT 360°  
 ROTATION

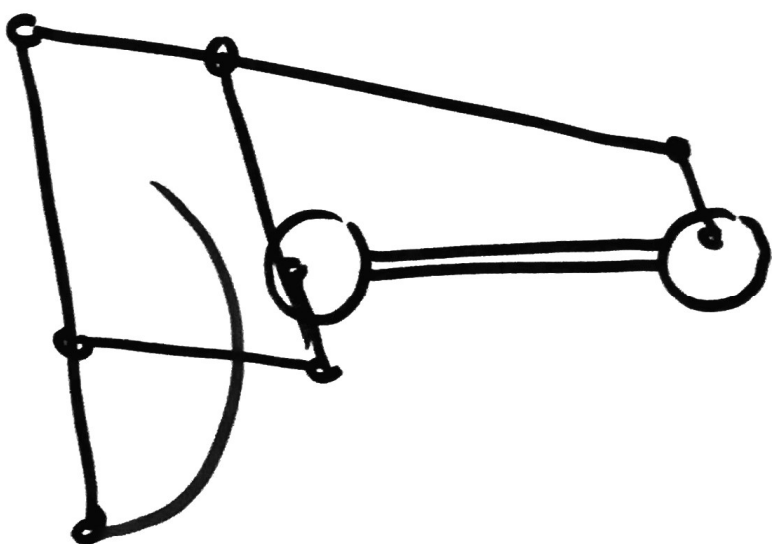
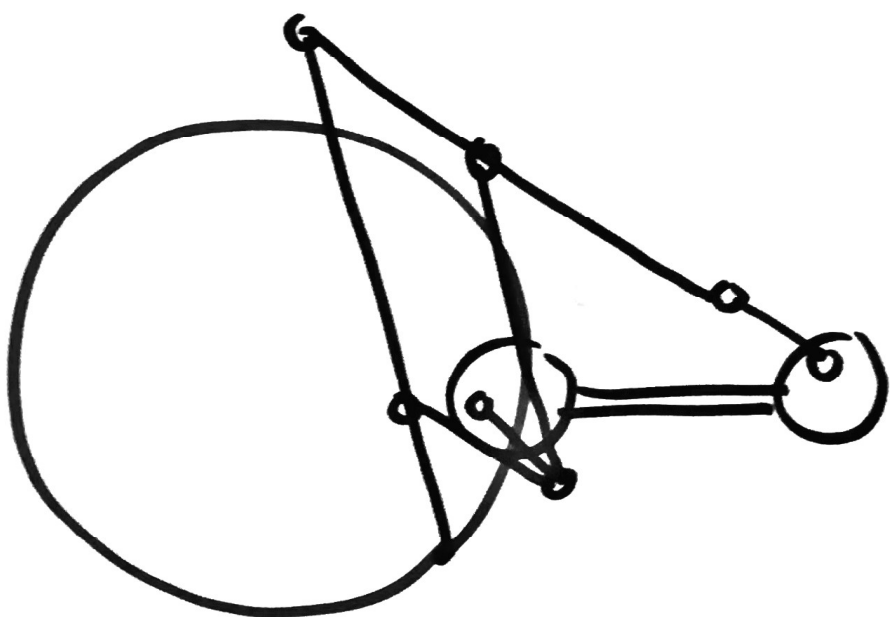
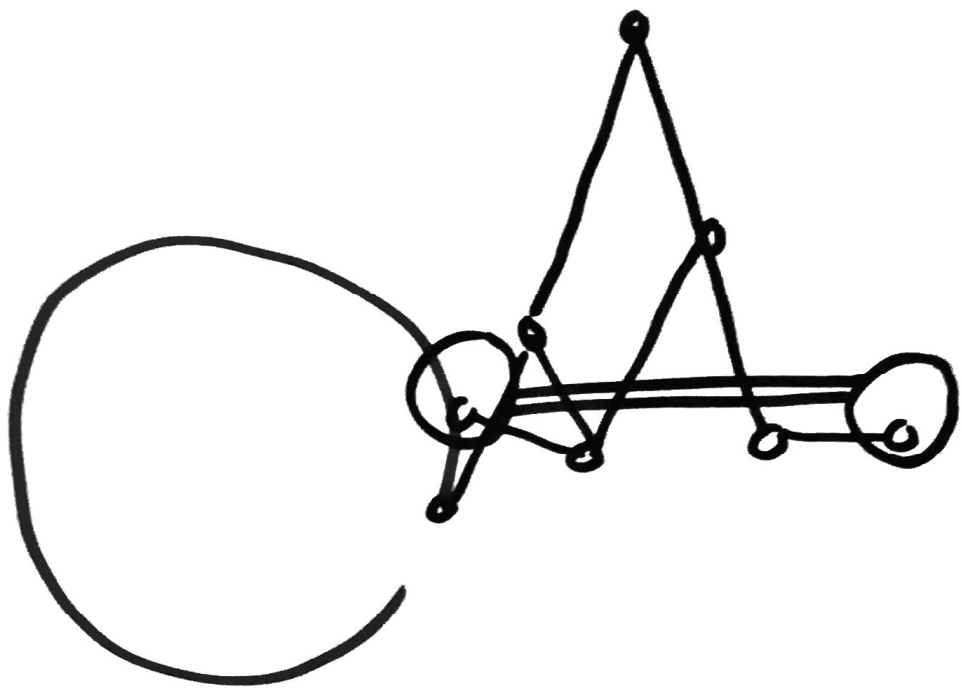



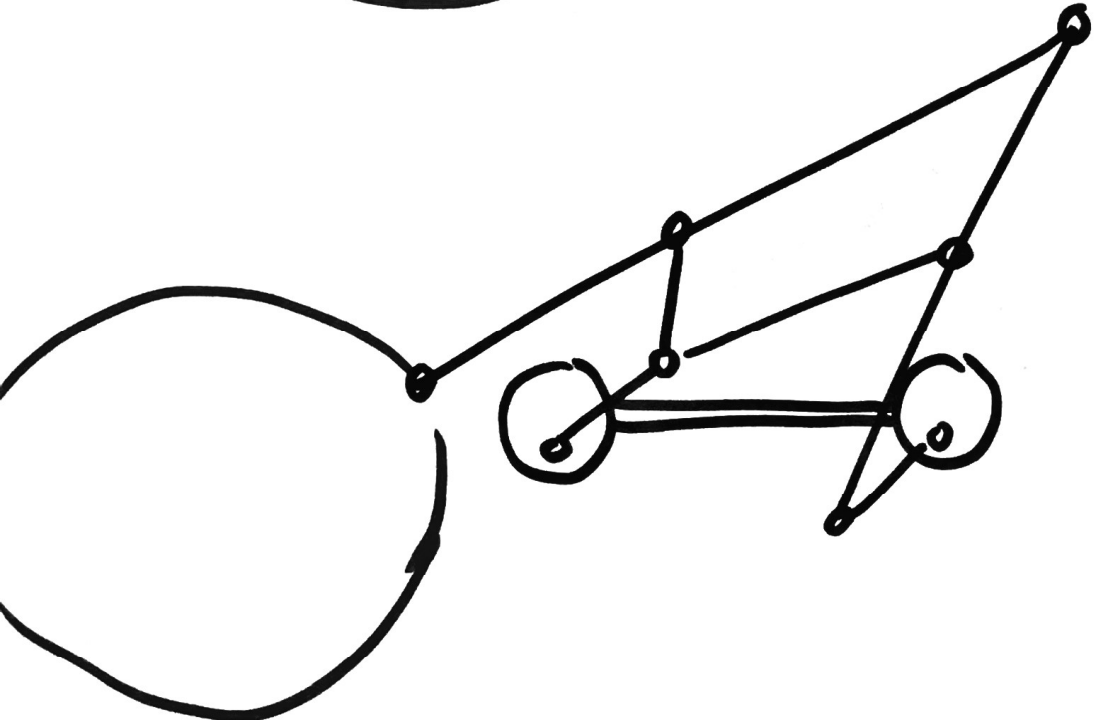
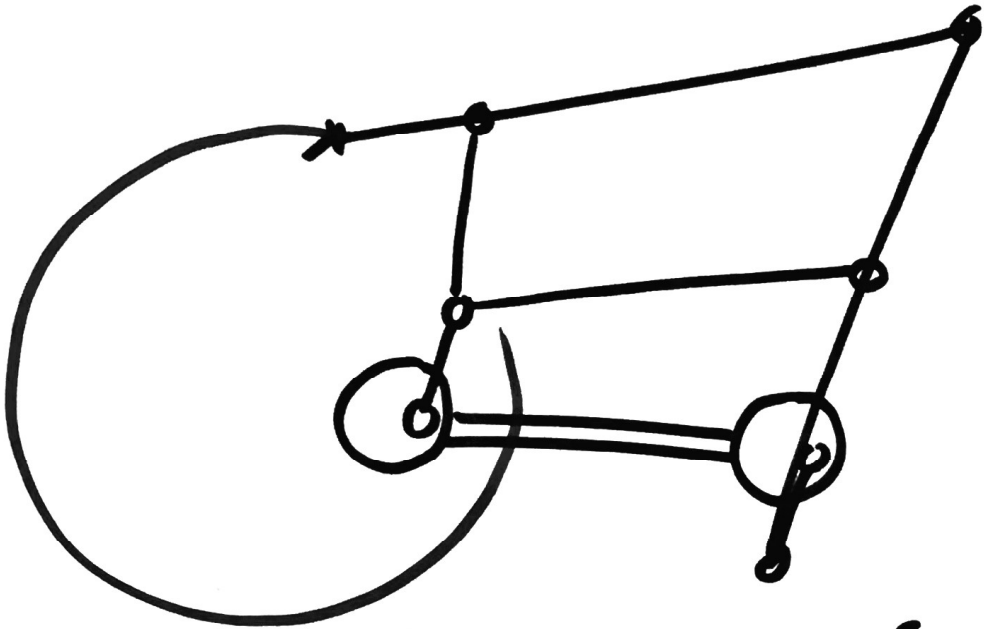
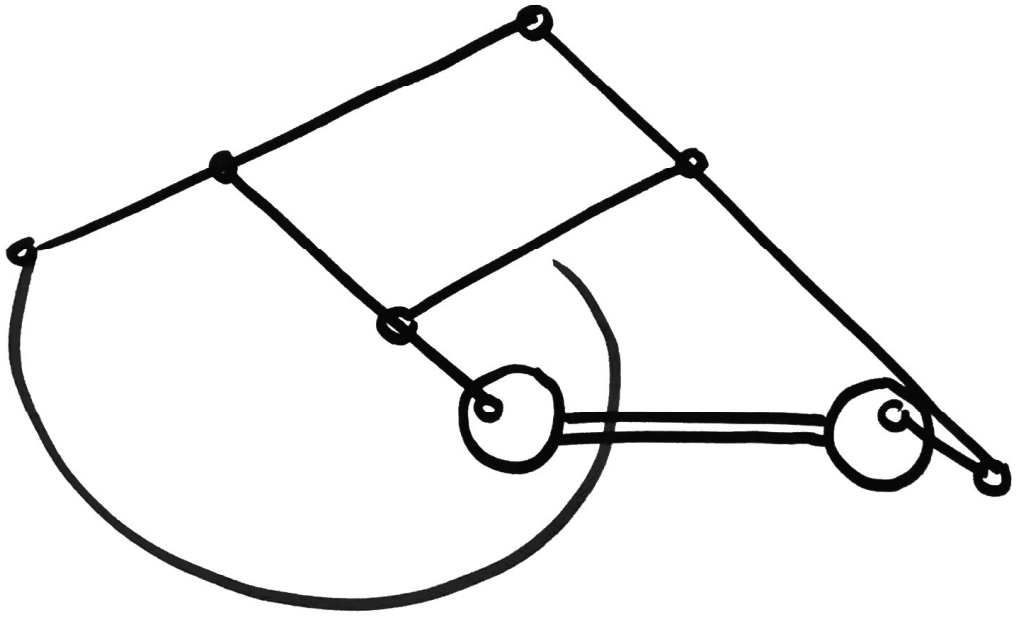

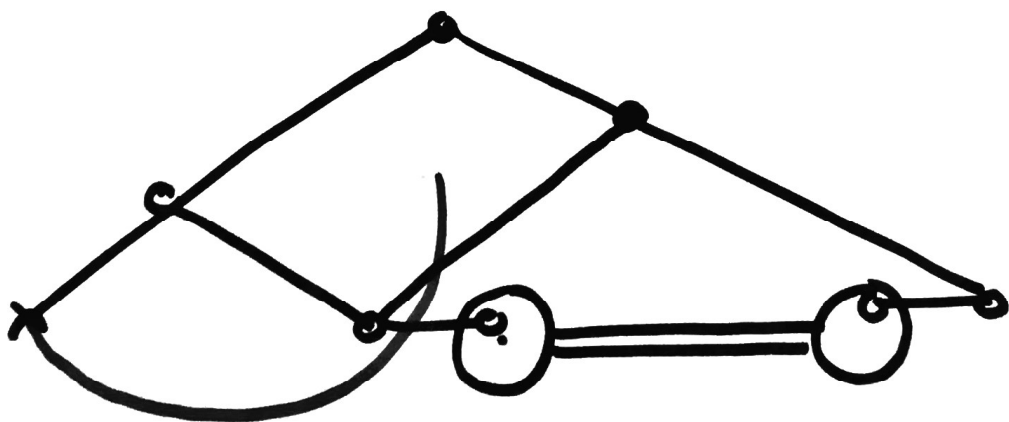
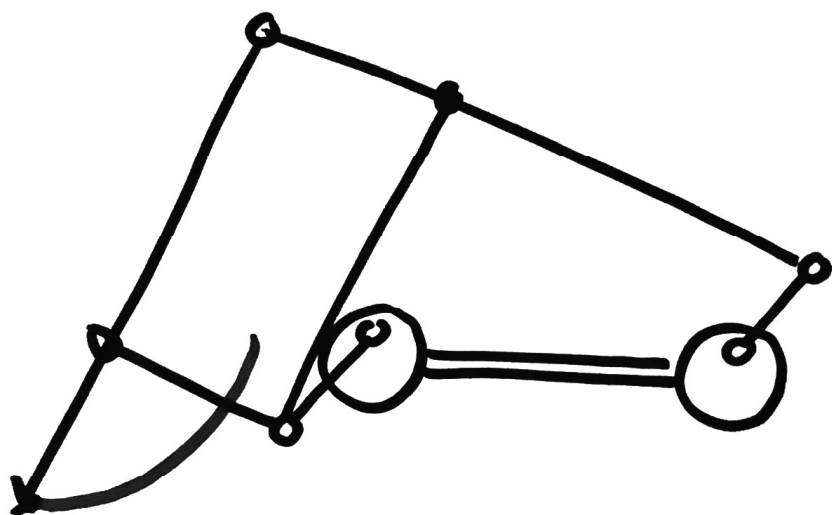
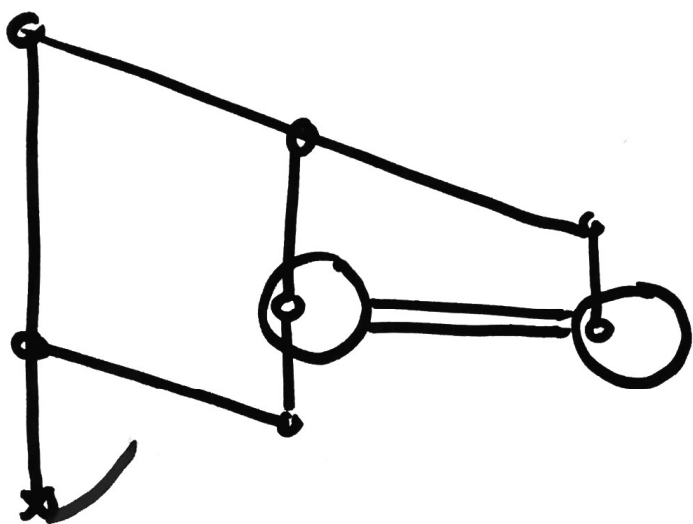

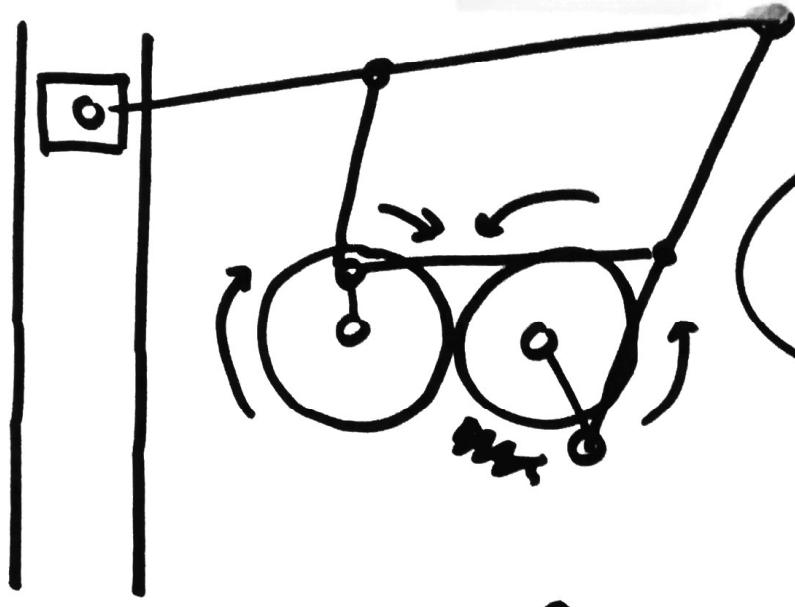

PANTOGRAPH  
(REVERSE  
ROTATION)

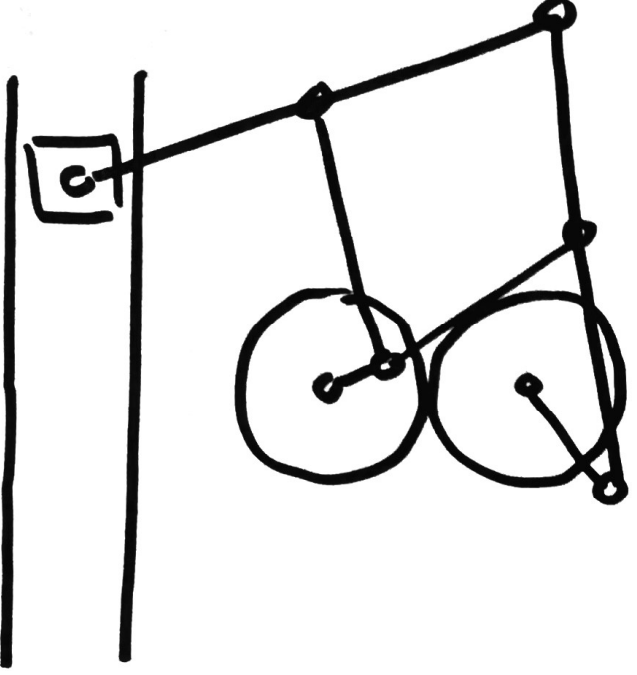

→ GEARS

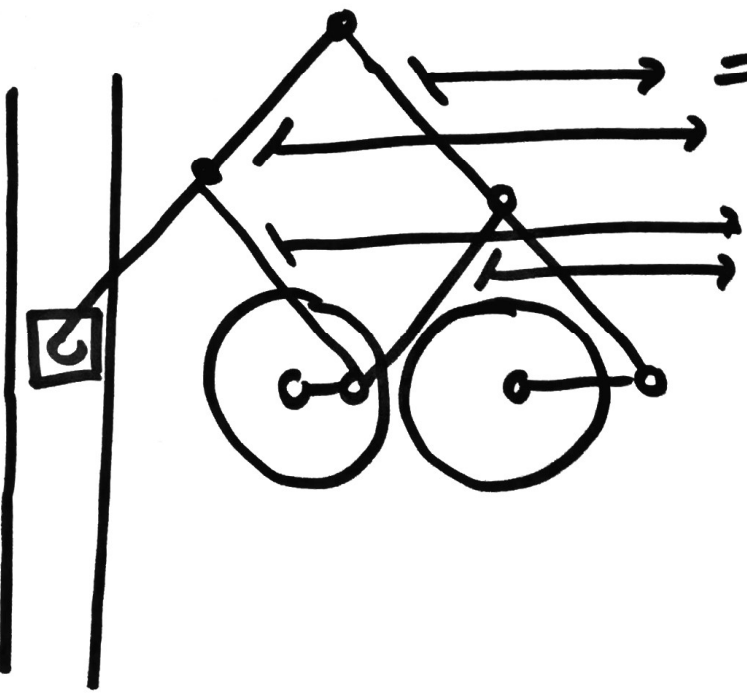

= LENGTH

= LENGTH

RECHENK STRAINE PAKS

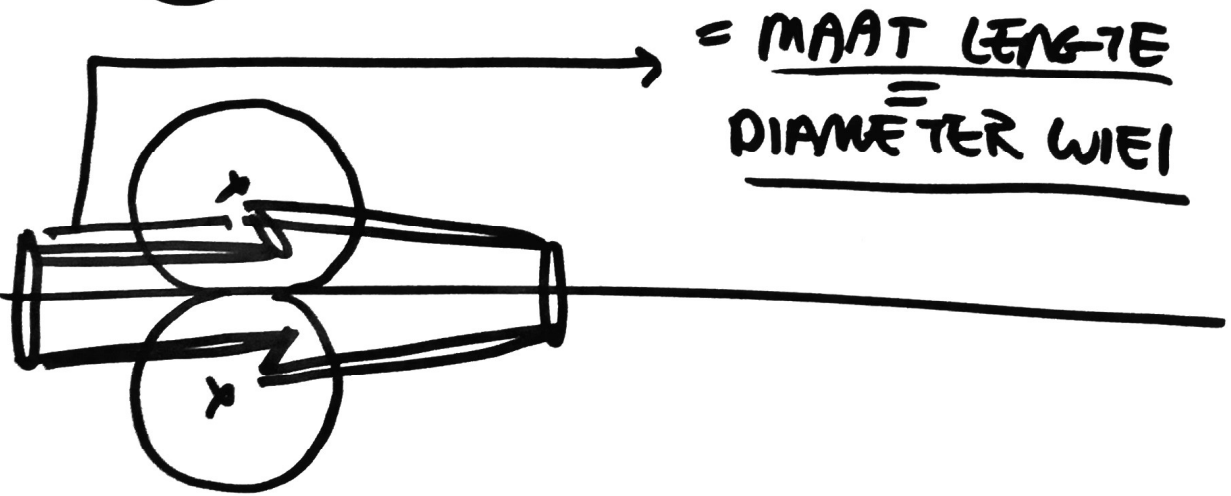
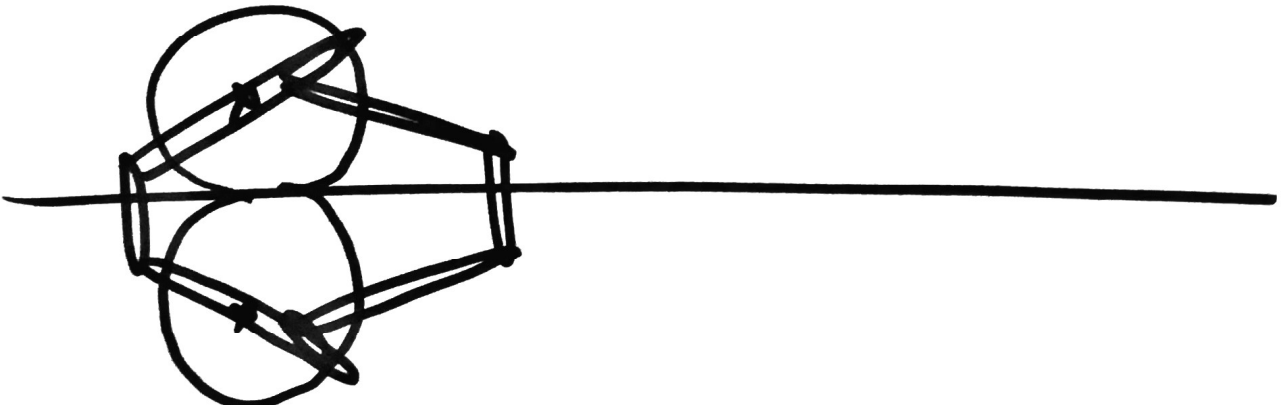
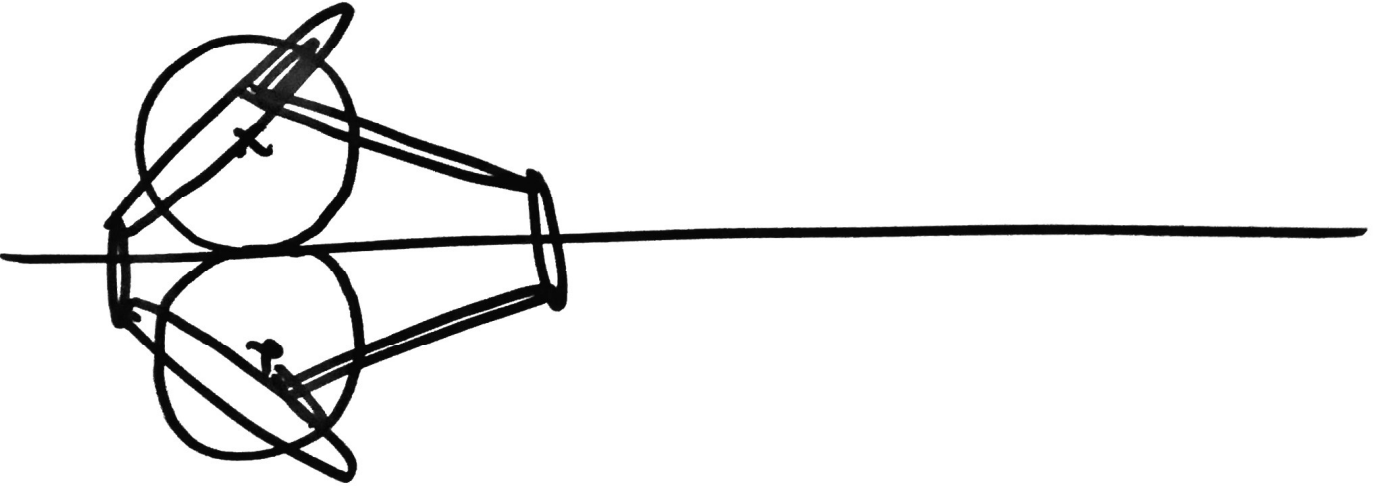

= MAAT LENGTE  
= DIAWETER WIEL

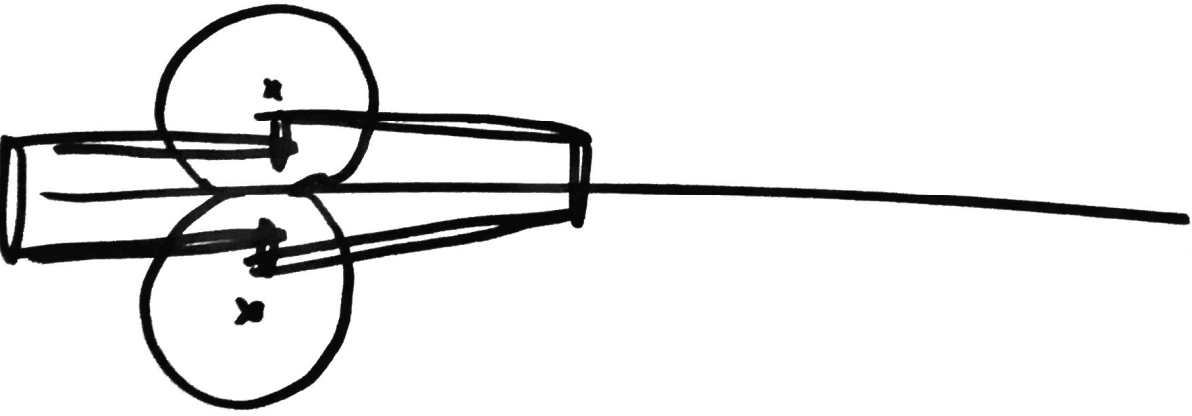

# RHOMBIC STRIPLING - PARTS

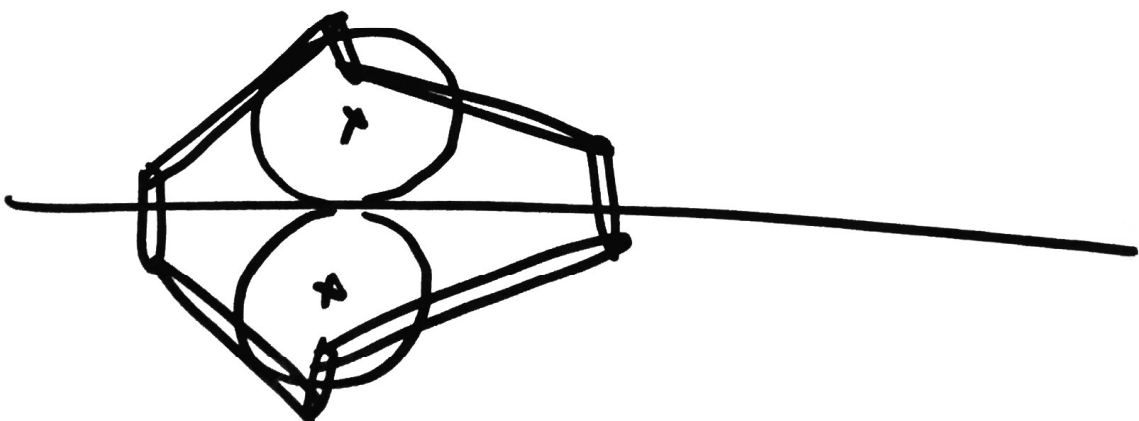
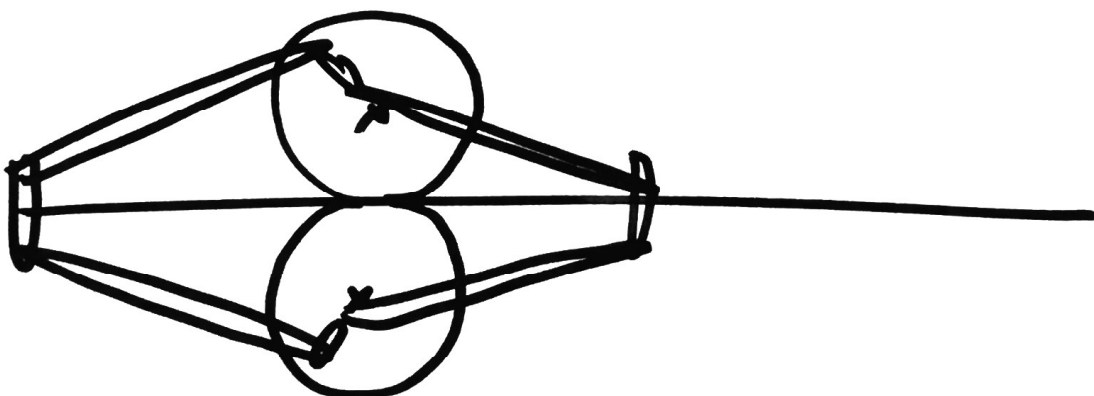
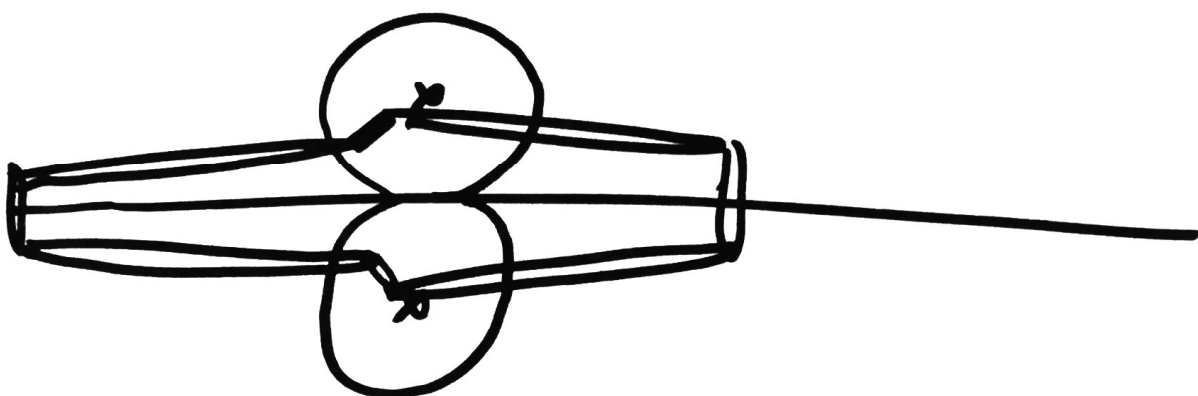
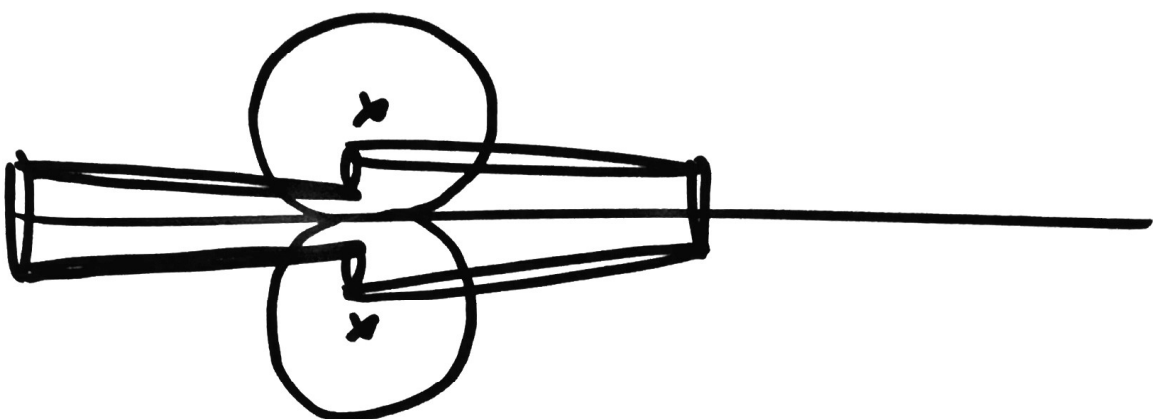

RHOMBIE  
STROMING

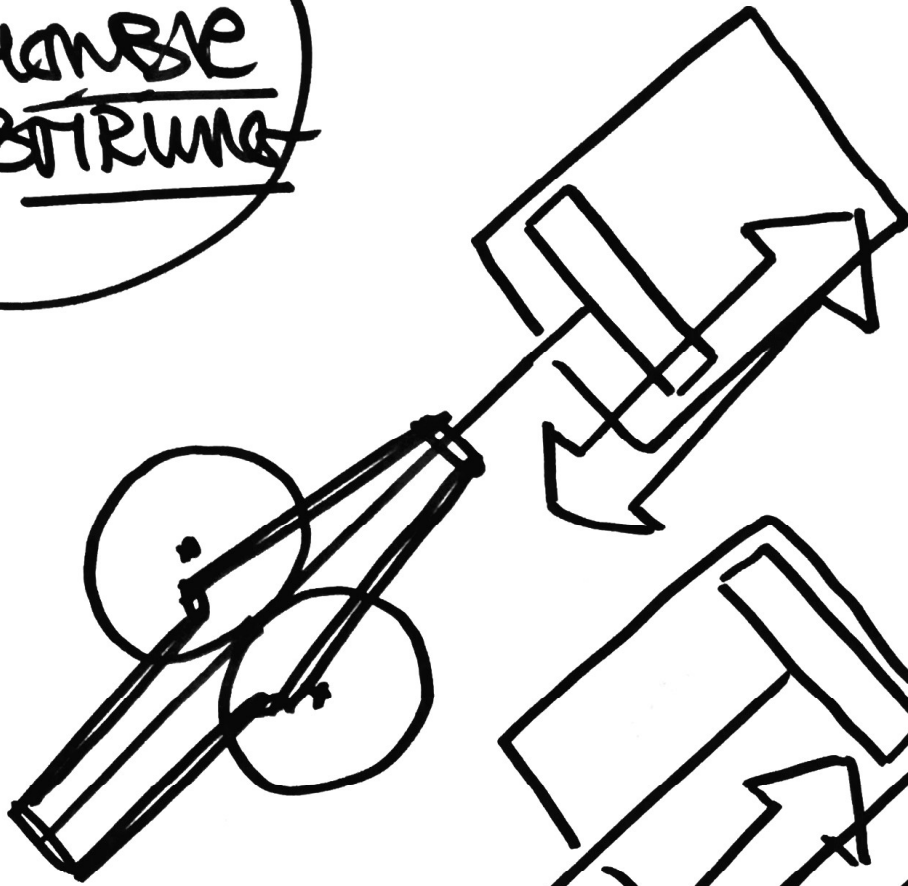

of ijs



QAO STRA

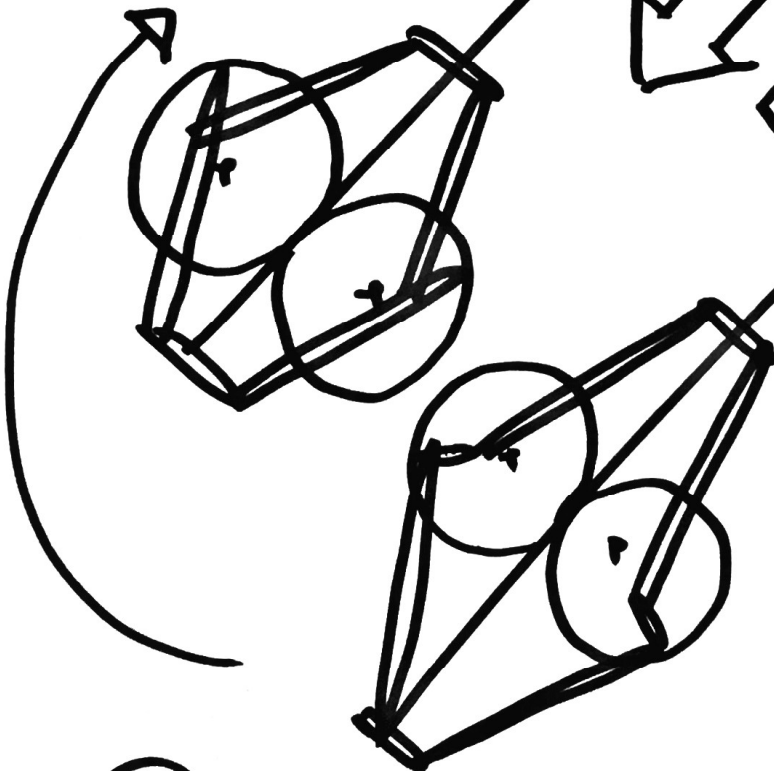

TEMP.  
VERSCHIL

Q: HOE GEVEELIG?  
LICHAAMSTEMP.?

# Solutions

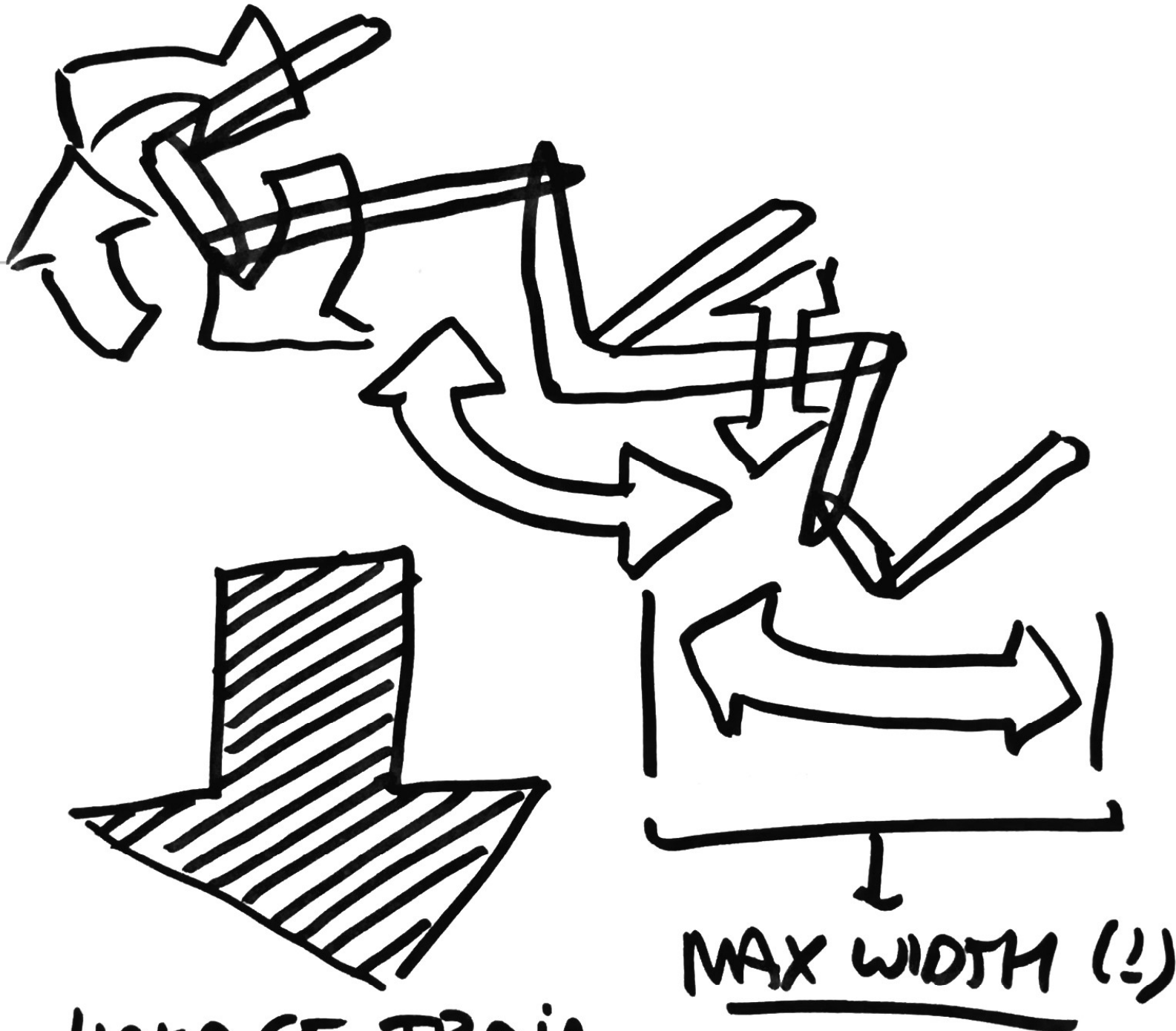

LINKAGE TRAIN  
DRIVE

FINANCIAL STATE  
UNNECESSARY

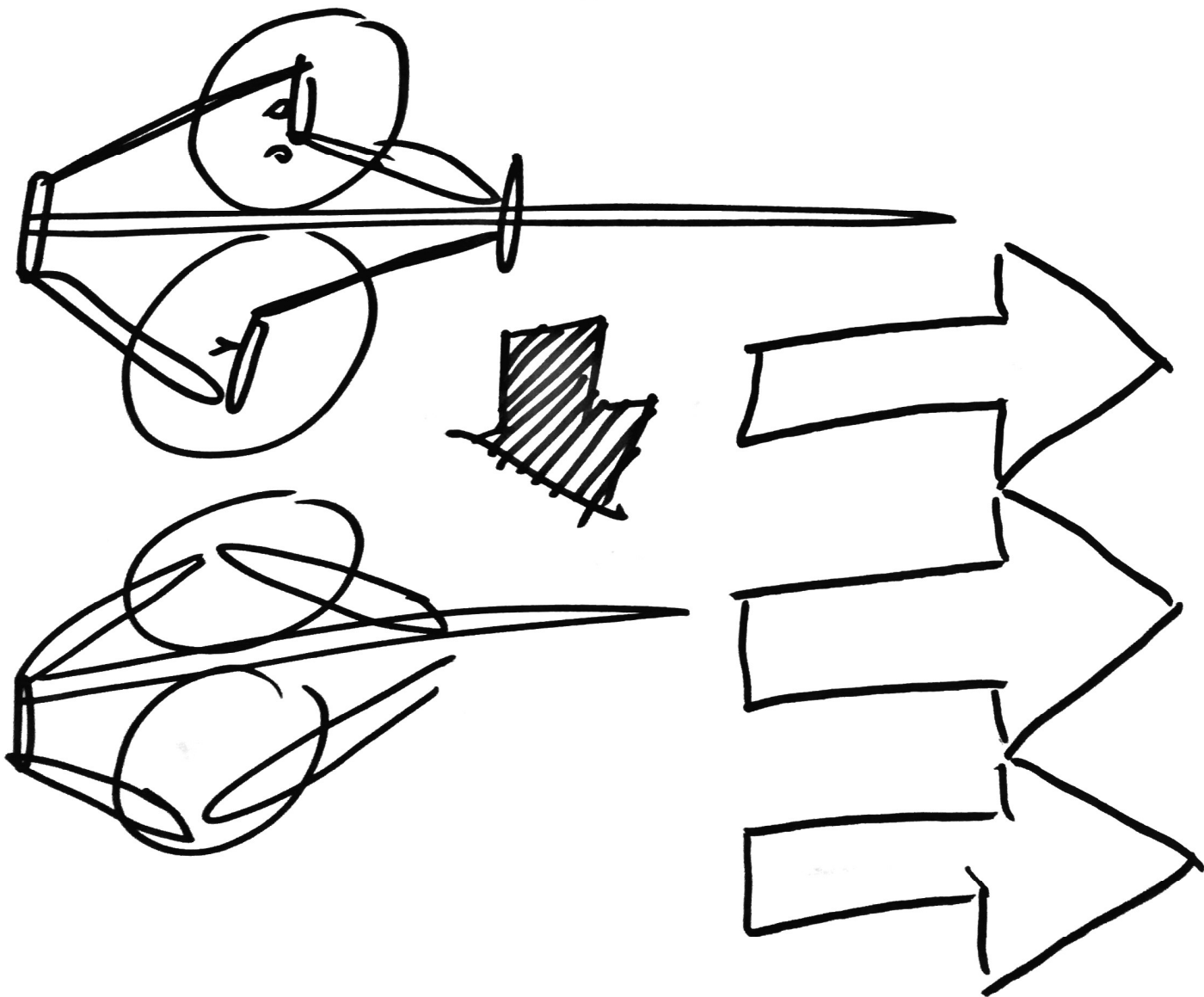



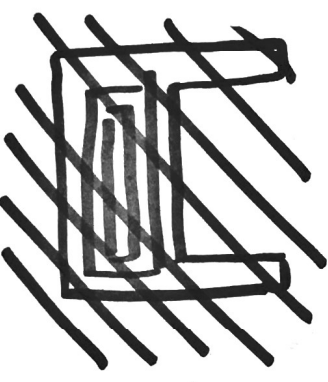
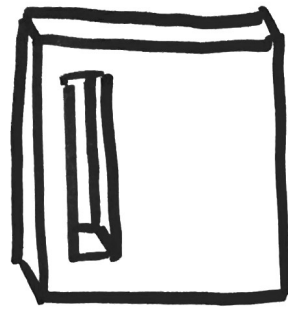

TUNNELS

IPV BRUG

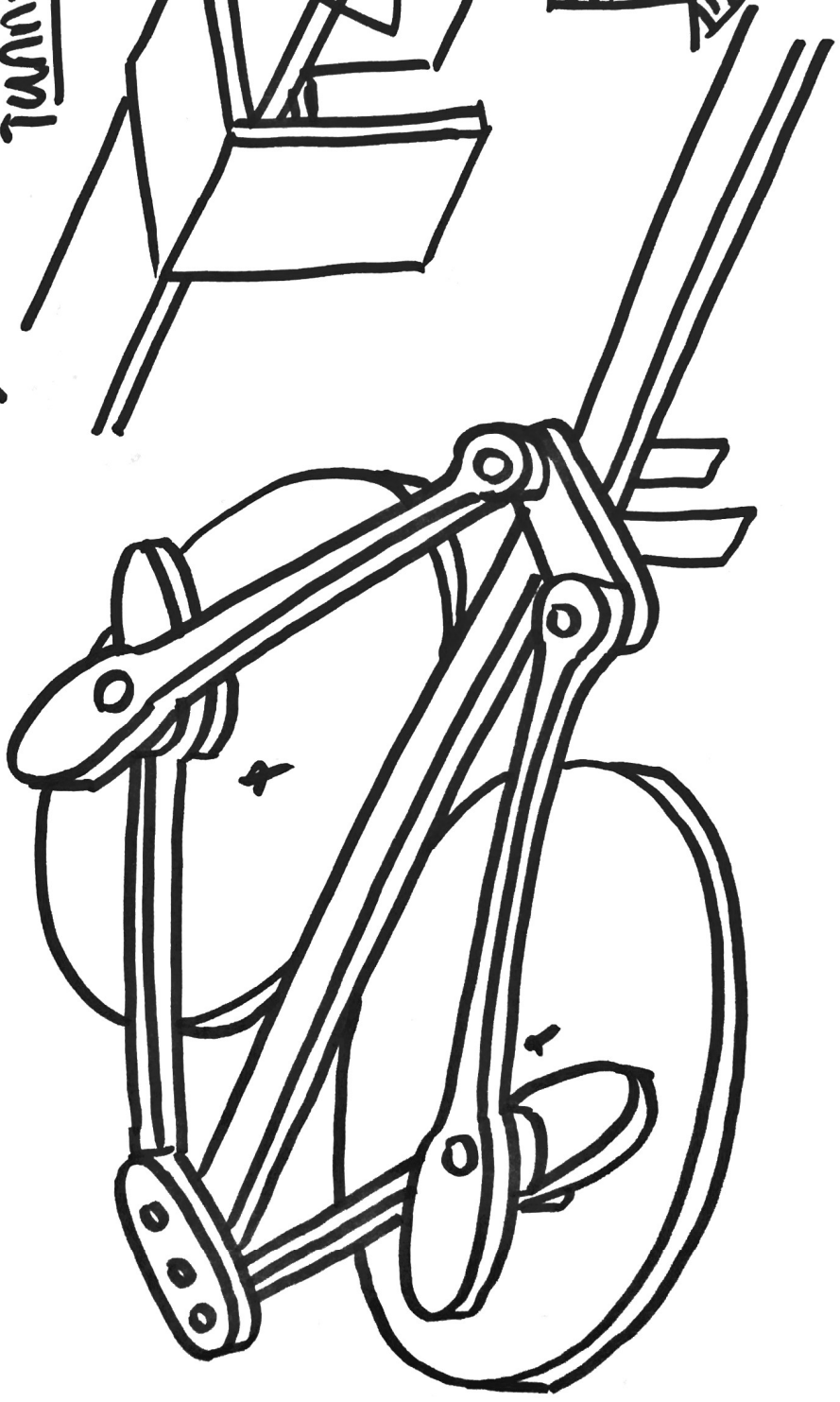

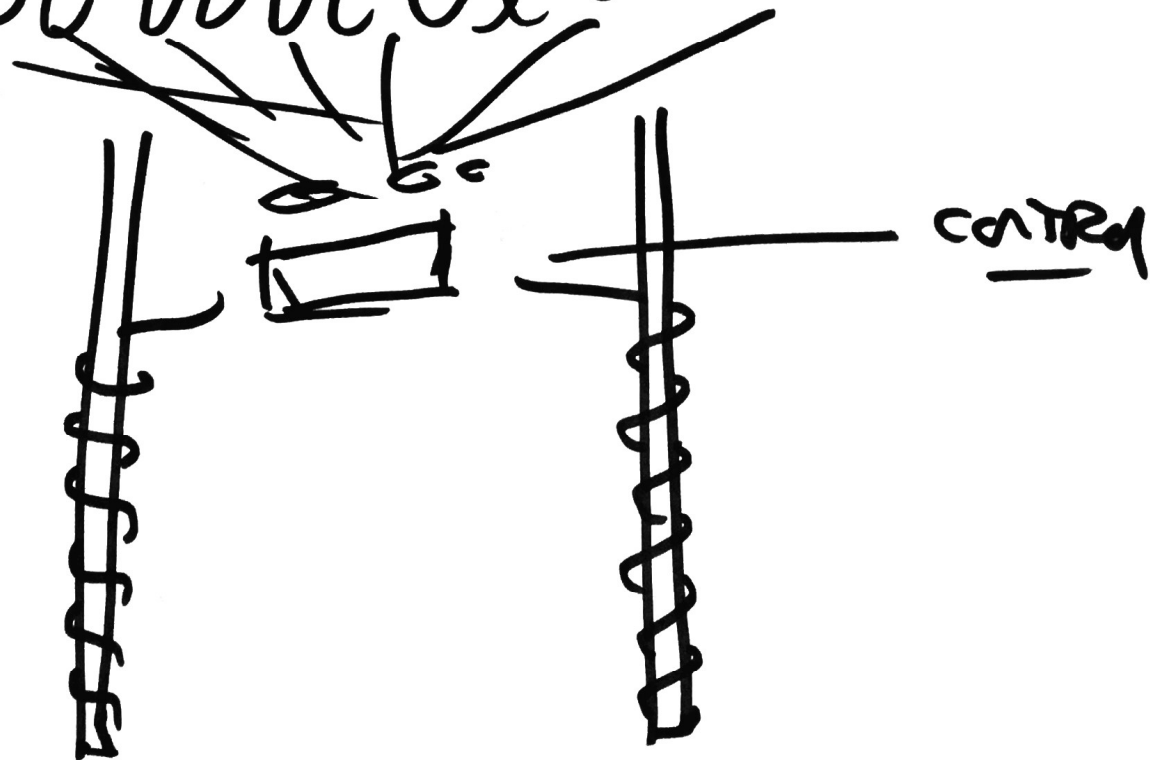
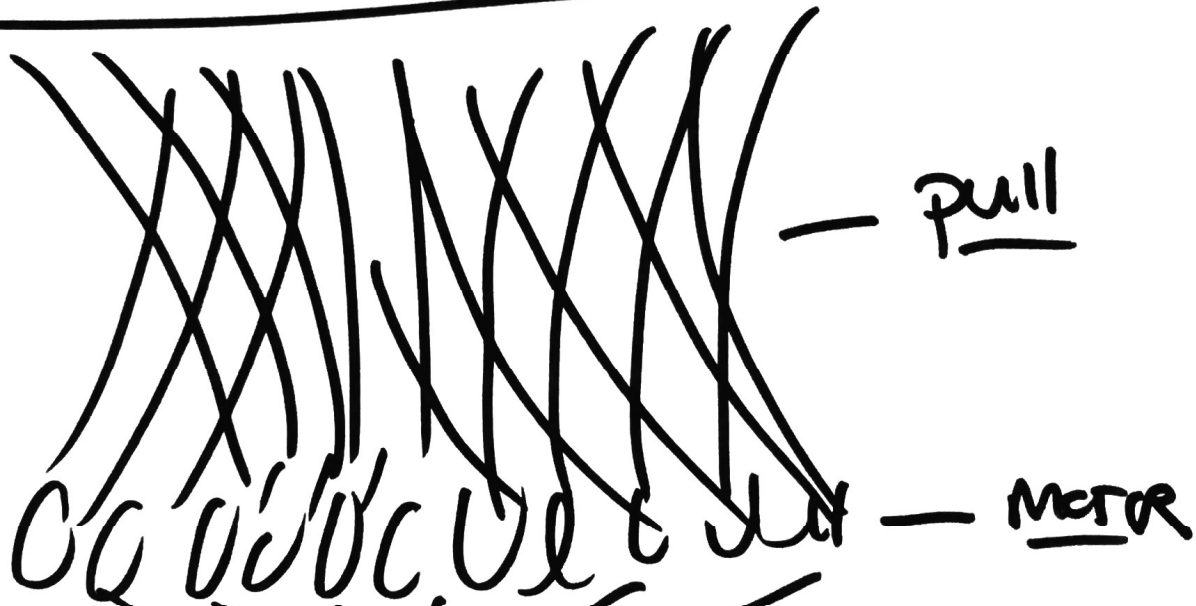

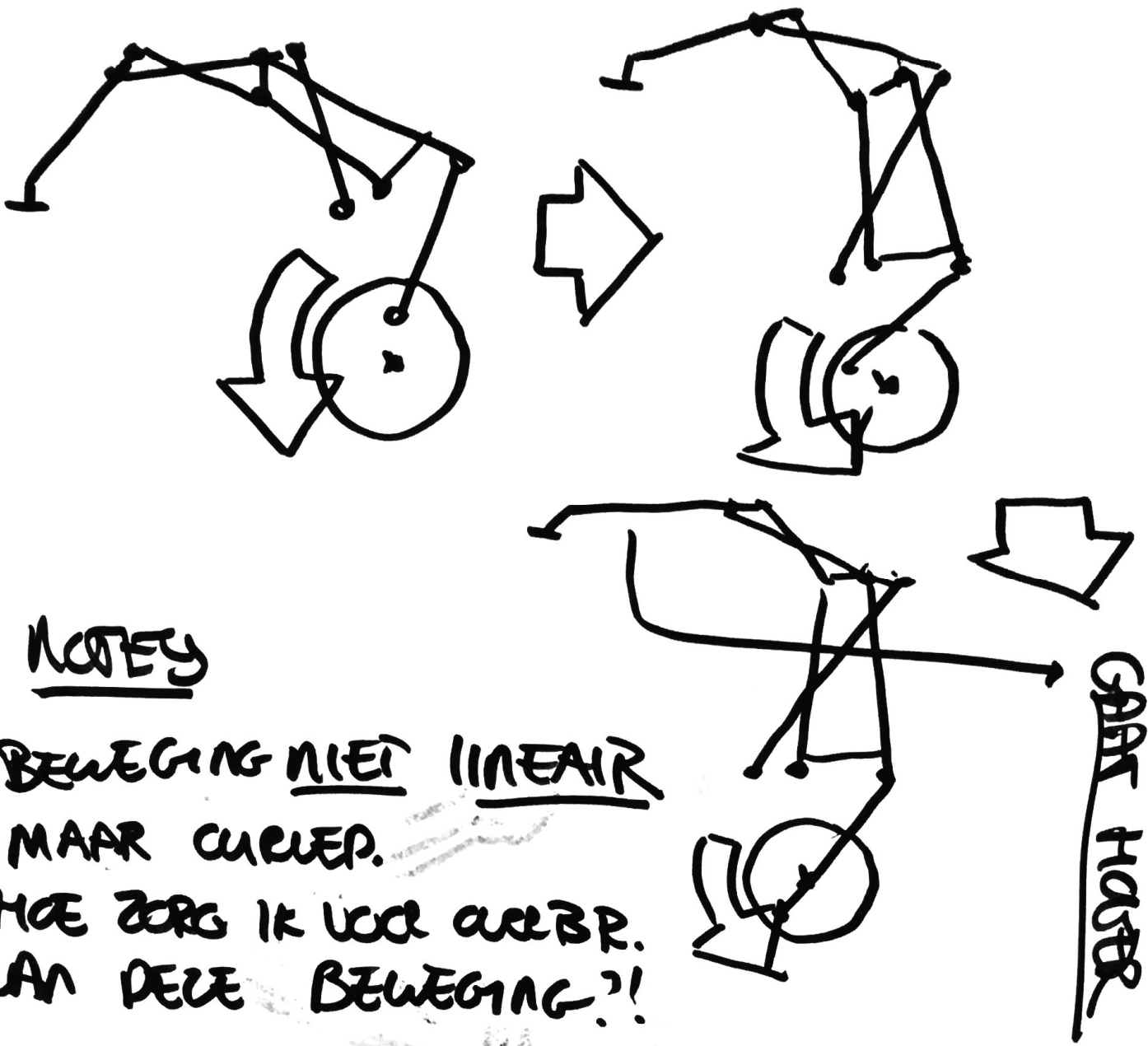

NOTES

BEWEGING NIET LINEAIR  
 MAAR CURVED.

→ HOE ZORG IK VOOR CURVE.  
 VAN DEZE BEWEGING?!

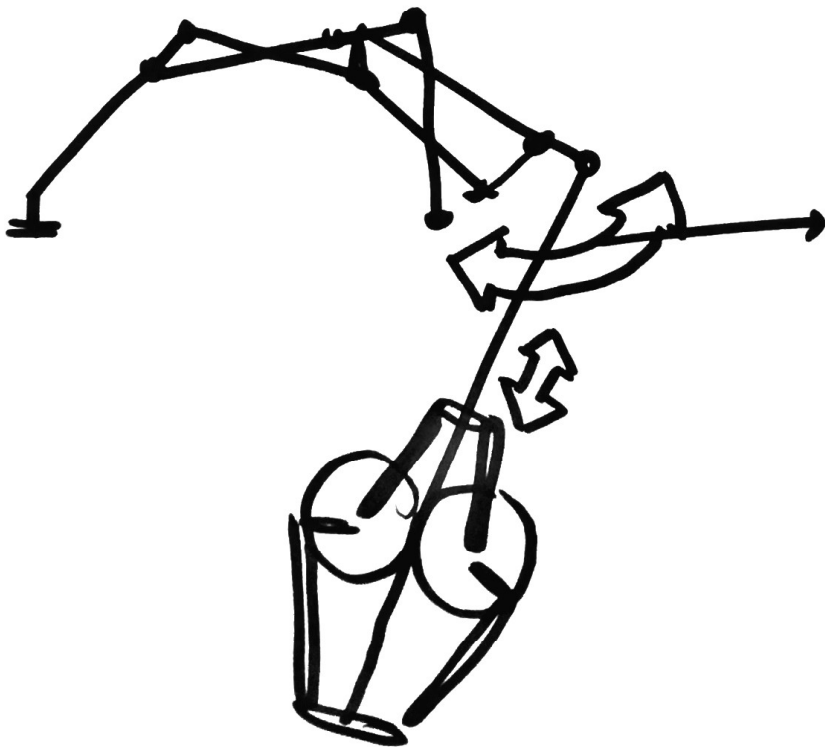



PROBLEM:  
LINEAIR VO CURVE

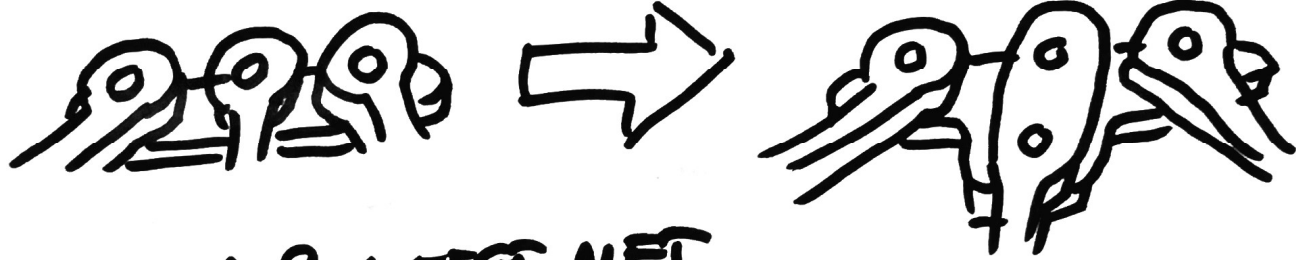

# [07/10] FIX FLIES

⊗  post + 6mm ipu 3mm  
+ ZAKKEN IN CONTRA  
(!) STEUN + PLAATSING

⊗   
  
(!) BEVEEGT MET  
MEER 

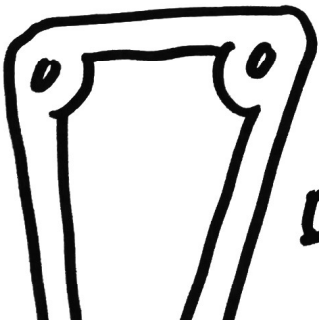
⊗  → LENGTE !!

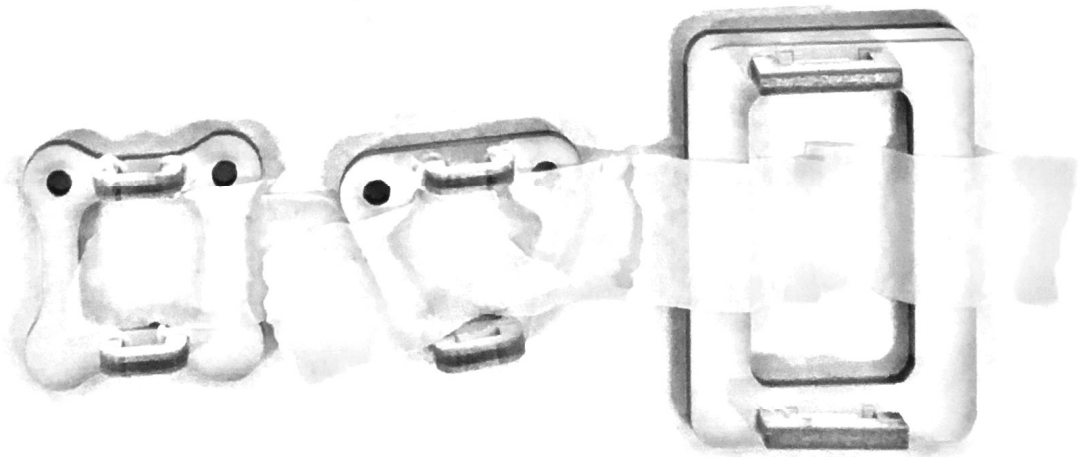

MB!!!

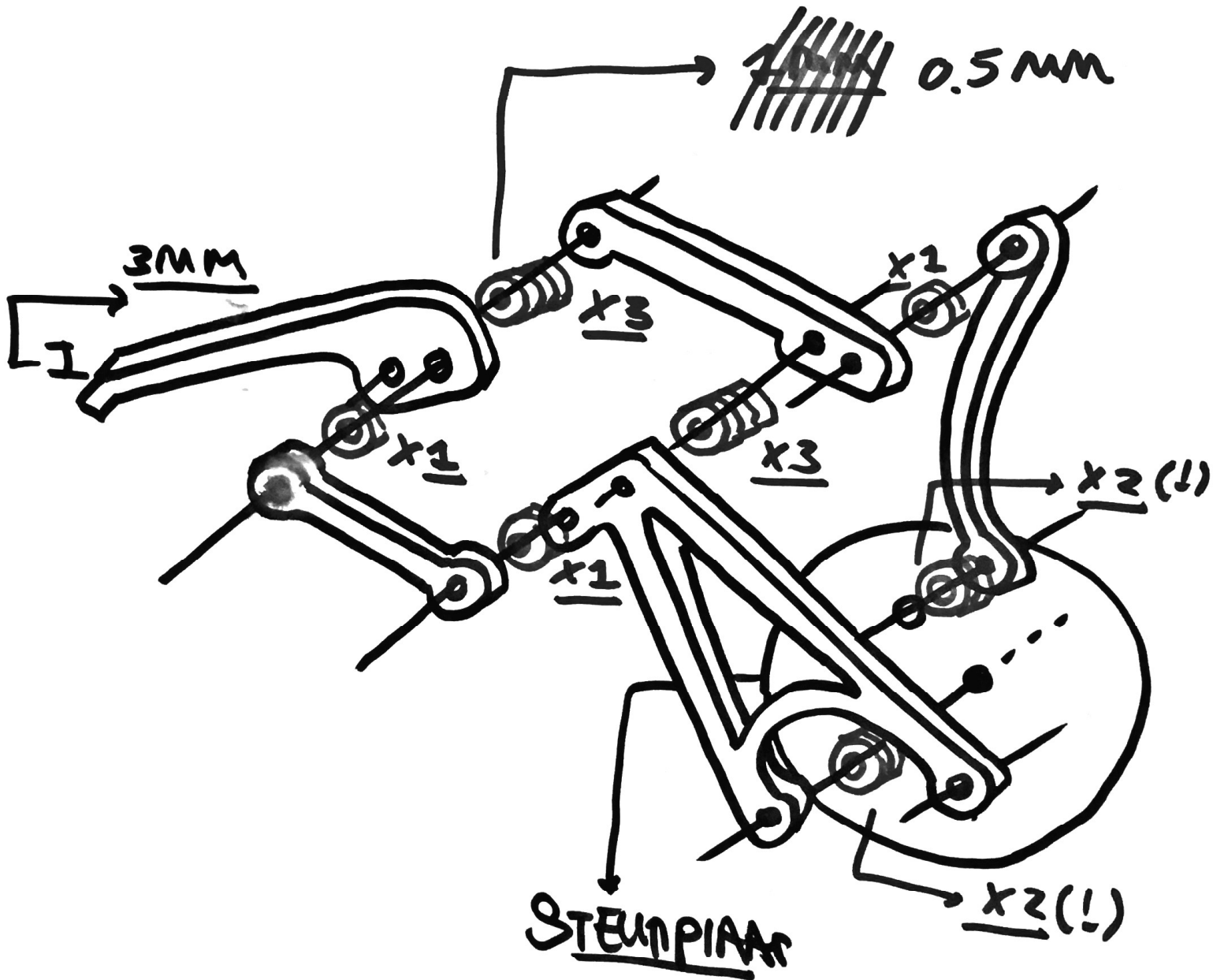

SMALLER

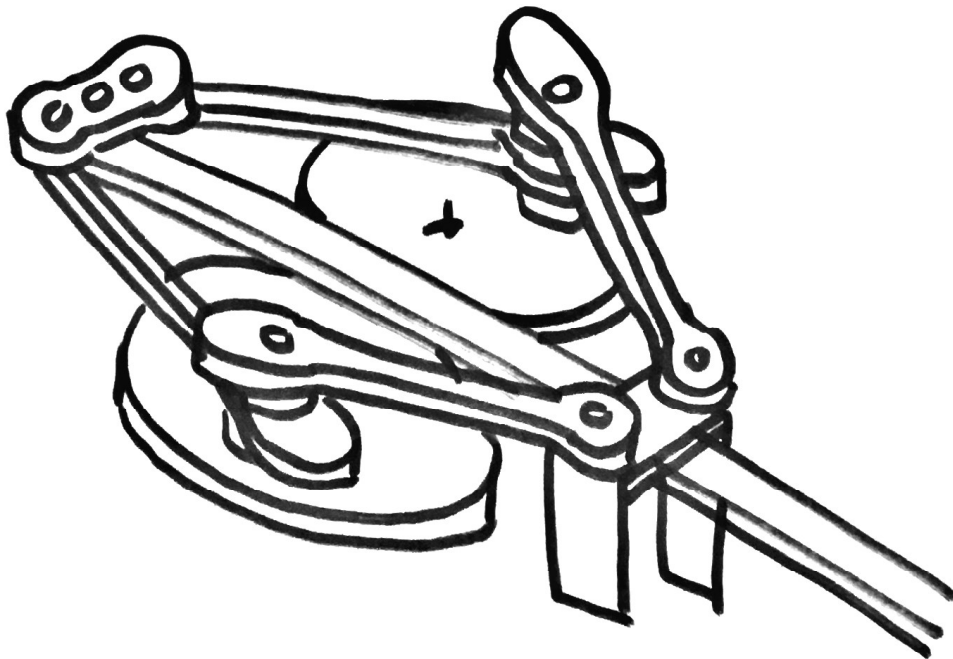
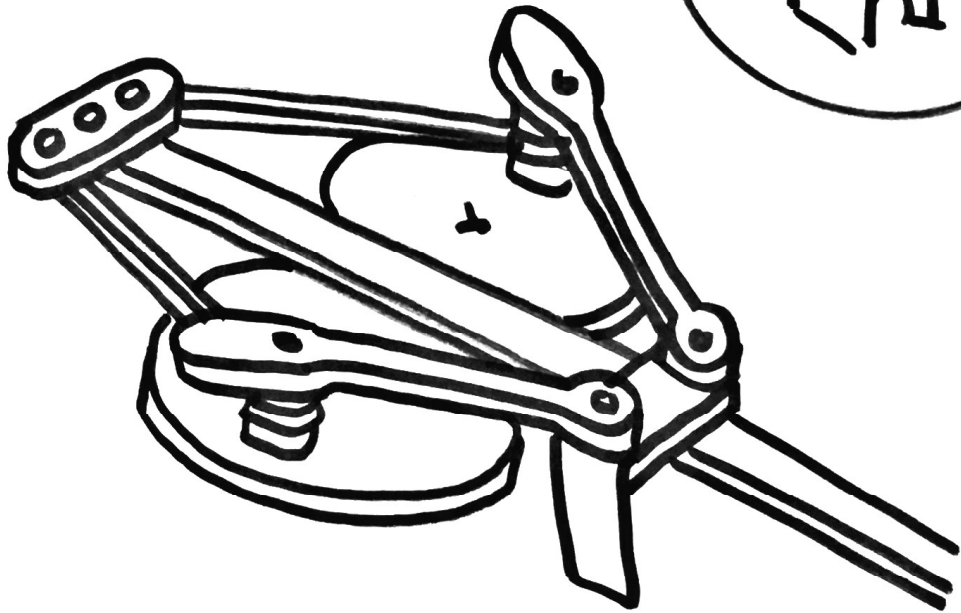
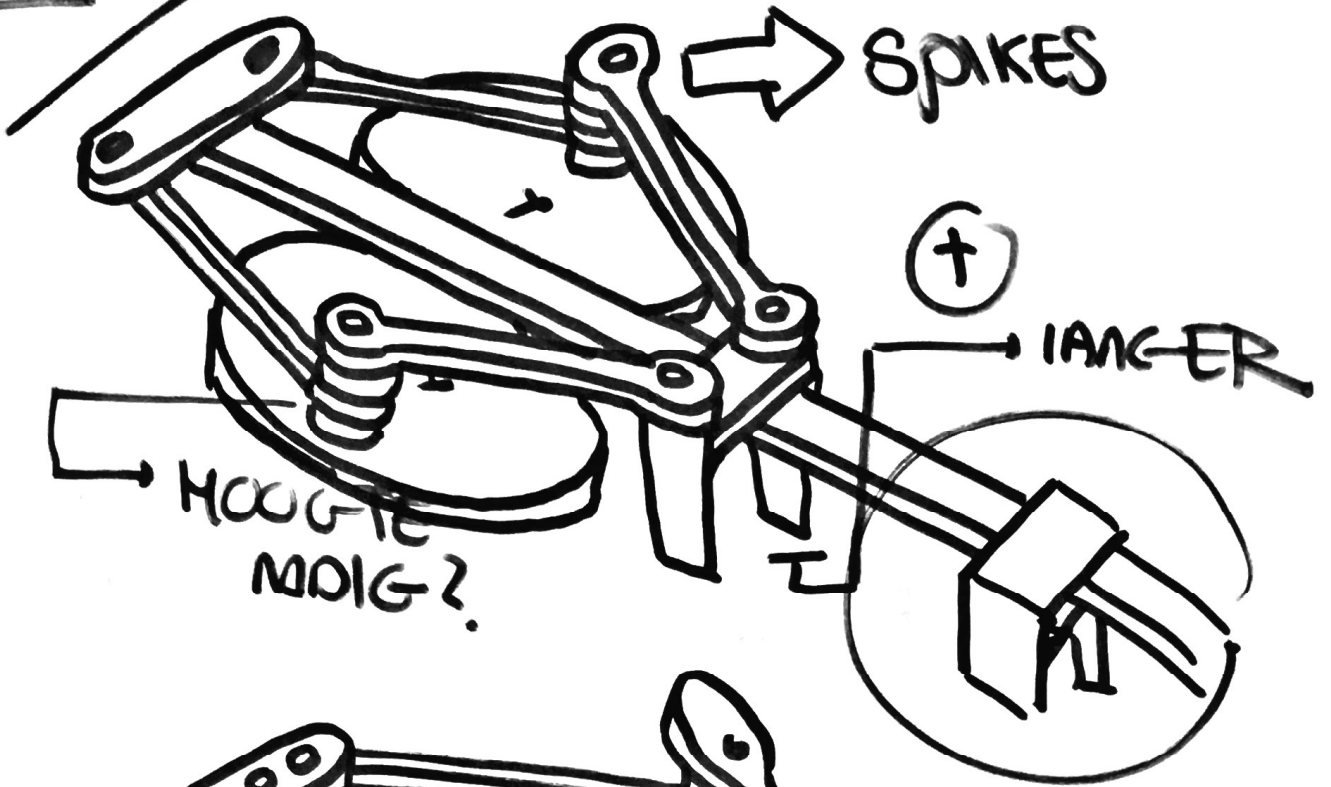

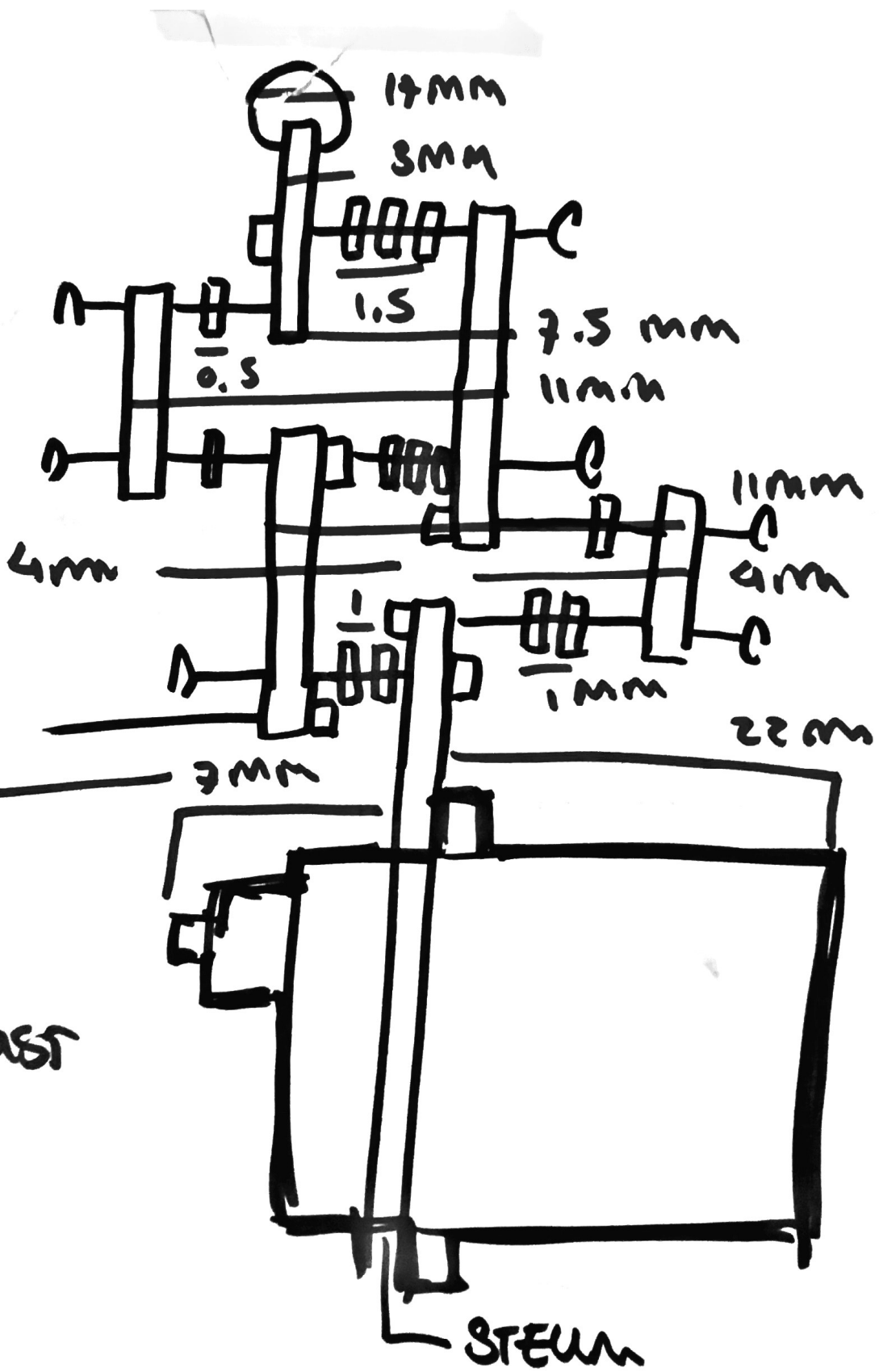

4mm  
DUS MUST  
3mm  
=



~~Handwritten scribbles~~

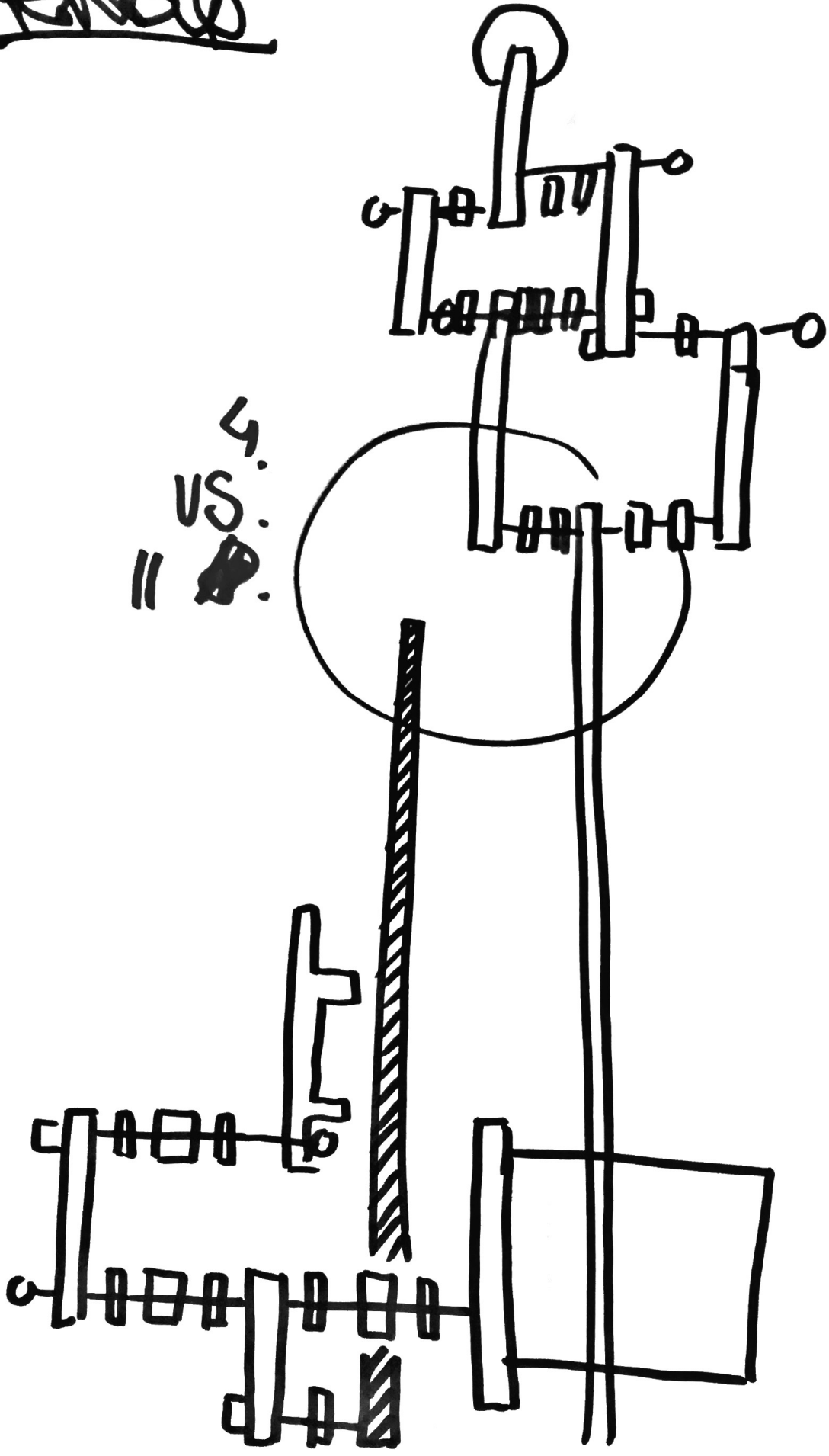

4.  
VS.  
||

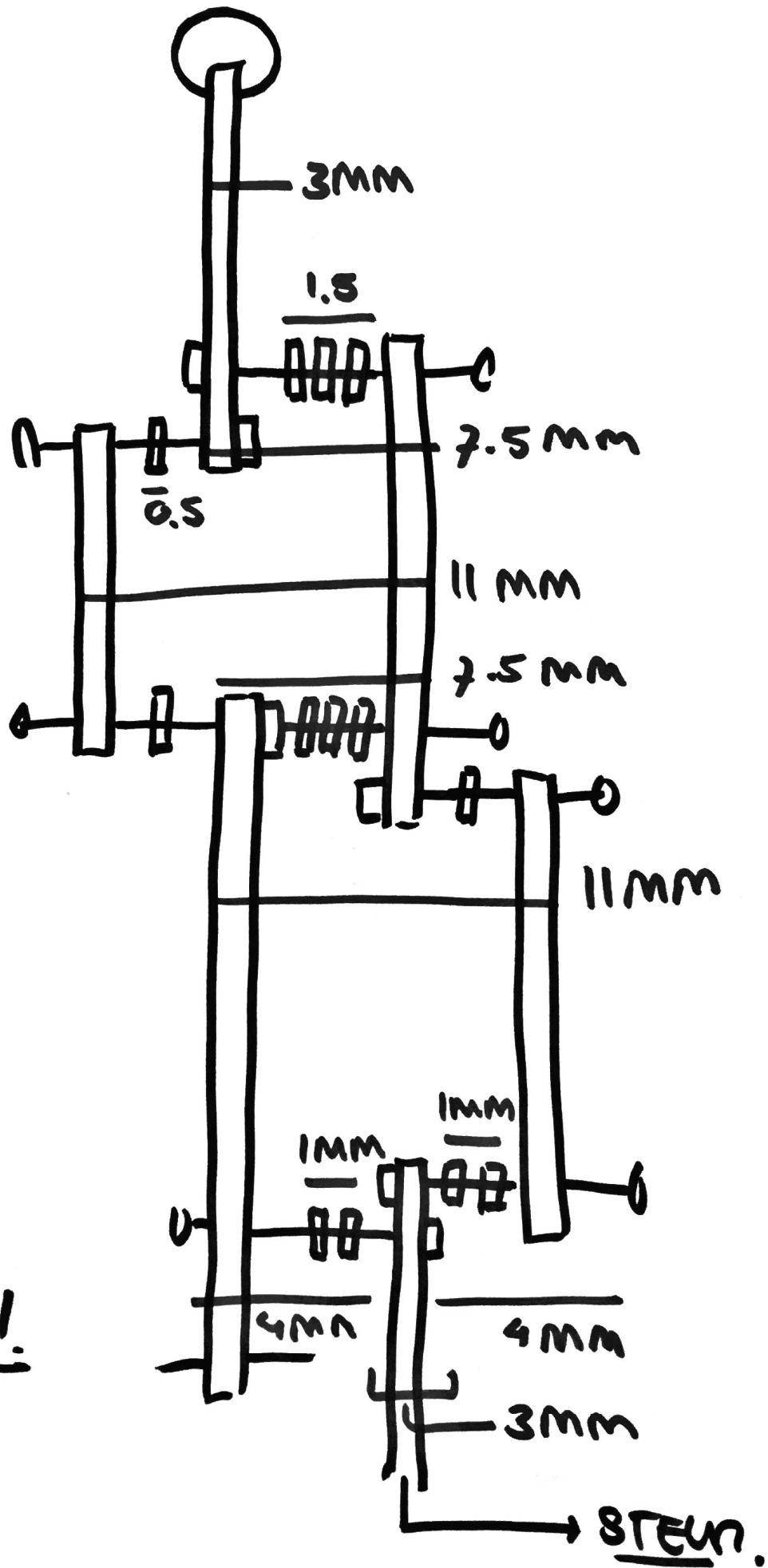

Q:  
 STERN +  
 MOTOR? !

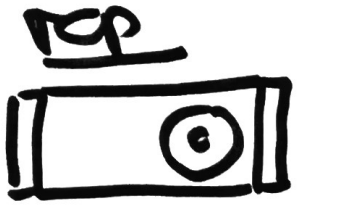

LONG SIDE

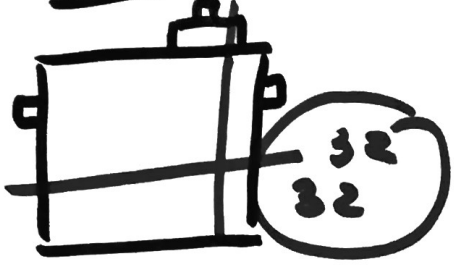

SHORT SIDE



THIS SIDE  
ALWAYS  
UP

4.5m

~~SEPARATE~~  
20

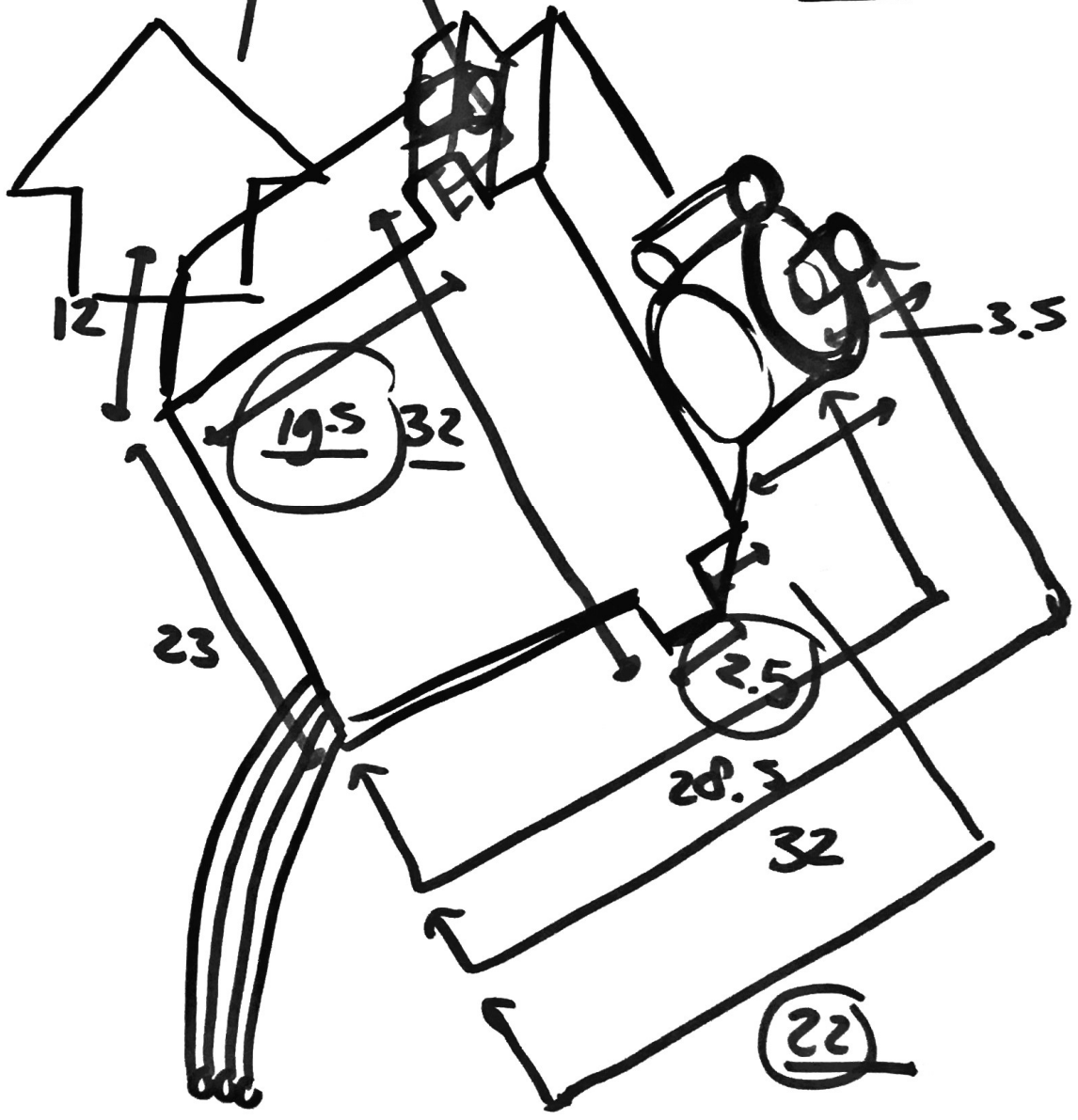

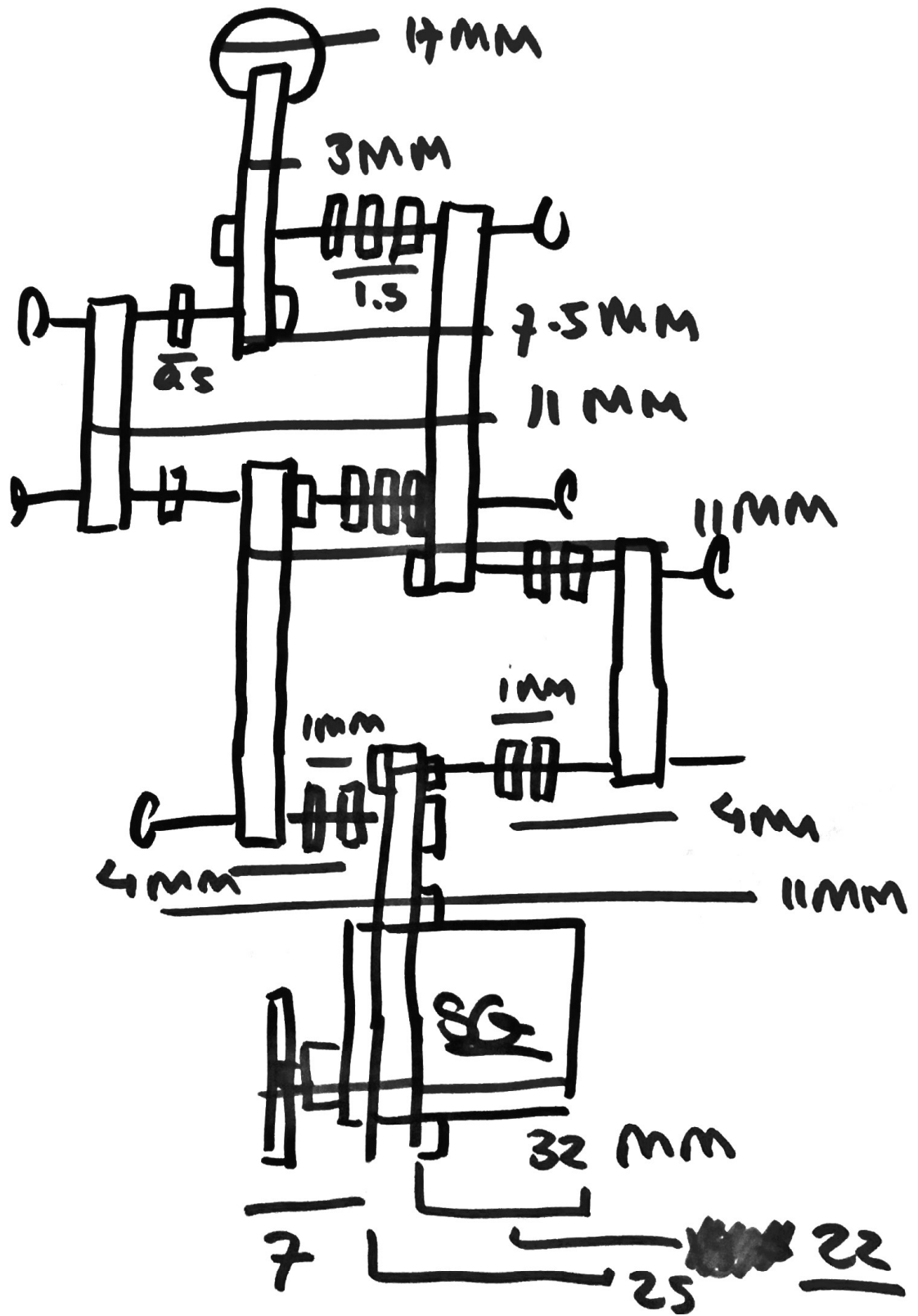

FRONTO

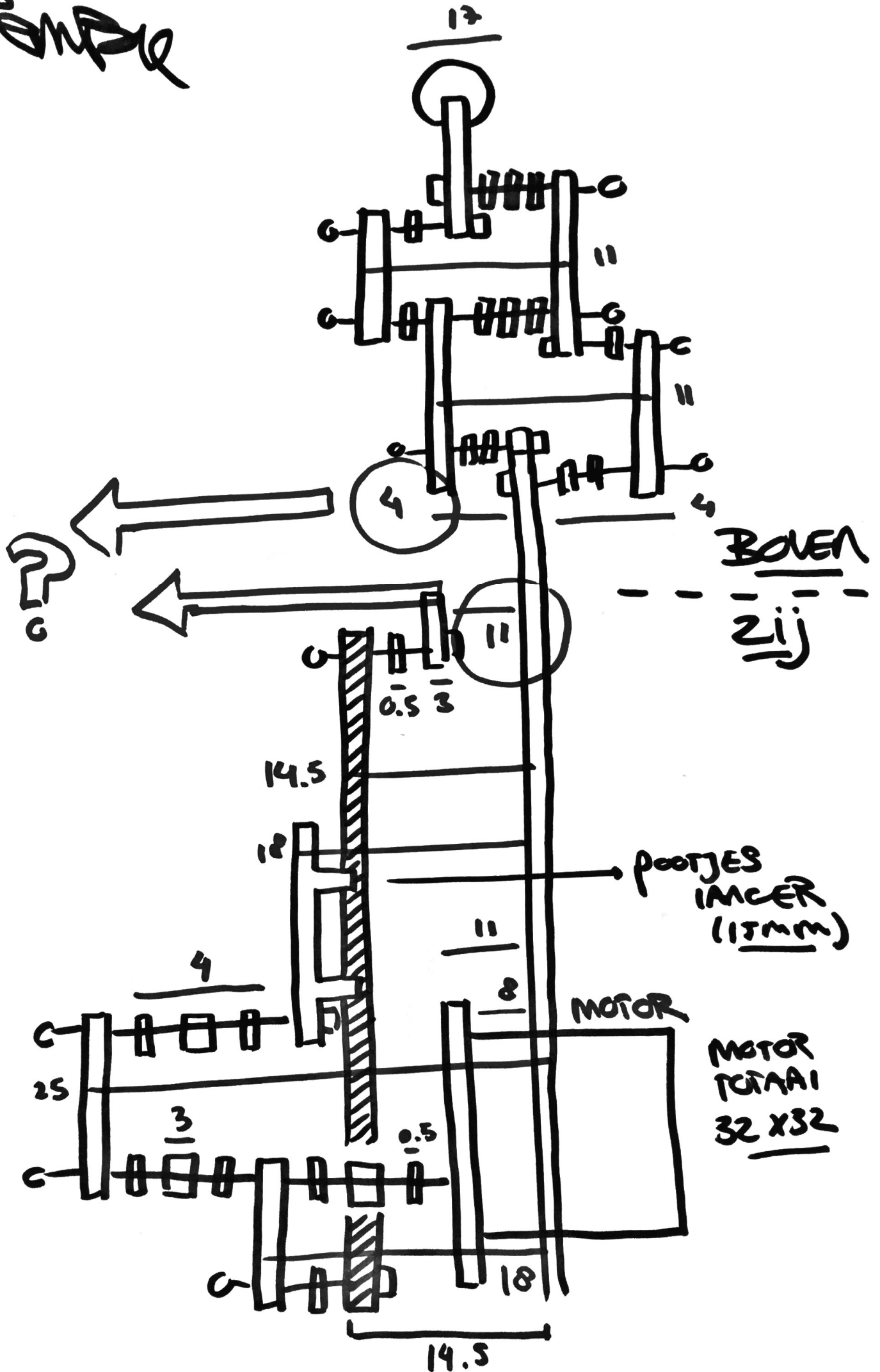

# BOUT (M3)

PIATKUP

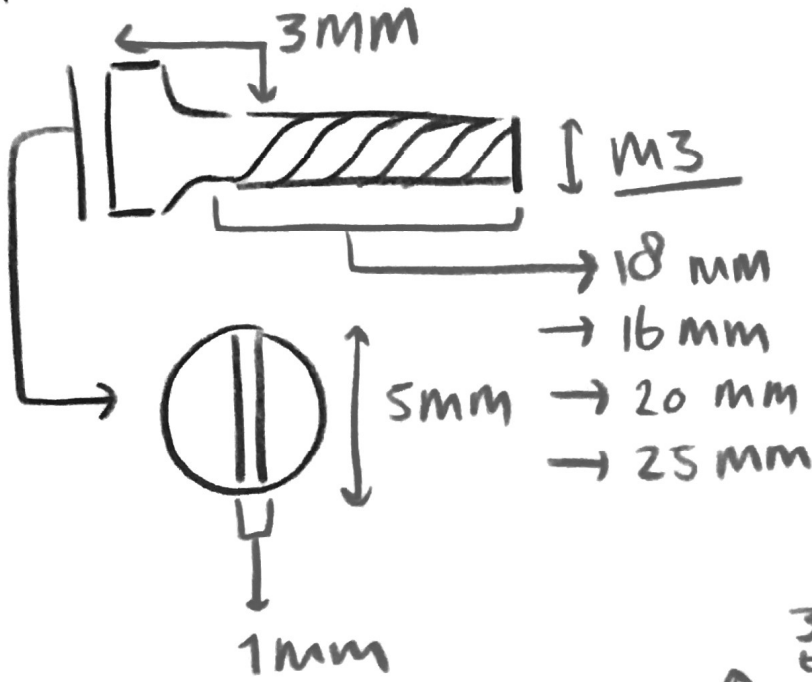

MOER

NORMAAL  
D BORG

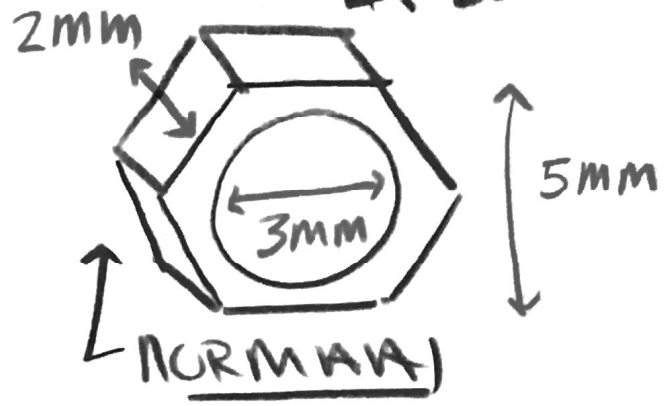

(!) ~~SKETCH UP~~  
 100% FREE  
 CAD

ARM 2

